

Laparoskopie
Laparoscopy

Content Inhalt

LITE-LINE TROCAR-SYSTEM	3	LITE-LINE TROKAR-SYSTEM	3
TROCAR-SYSTEMS & ACCESSORIES	4 - 7	TROKAR-SYSTEME & ZUBEHÖR	4 - 7
SUCTION & IRRIGATION SYSTEMS	8 - 9	SAUG- & SPÜL-SYSTEME	8 - 9
MODULAR SUCTION-/IRRIGATION SYSTEM	10	MODULARES SAUG-/SPÜLSYSTEM	10
MODULAR SUCTION-/IRRIGATION HANDLES	11	MODULARE SAUG-/SPÜLHANDSTÜCKE	11
MONOPOLAR HF-ELECTRODES	12 - 13	MONOPOLARE HF-ELEKTRODEN	12 - 13
MONOPOLAR CABLES	14	MONOPOLARE KABEL	14
"WOUND CLOSURE" FORCEPS	15	"WOUND CLOSURE" INSTRUMENT	15
ACCESSORIES	16 - 18	ZUBEHÖR	16 - 18
BIPOLAR FORCEPS	19 - 23	BIPOLARE ZANGEN	19 - 23
BIPOLAR SILICON CABLES	24	BIOPOLARE SILIKONKABEL	24
INSTRUMENTS ROTATABLE-/DETACHABLE	25 - 26	INSTRUMENTE DREH-/ZERLEGBAR	25 - 26
5 mm GRASPING & DISSECTING FORCEPS	27 - 32	5 mm FASS- & DISSEKTIONSZANGEN	27 - 32
5 mm BIOPSY-FORCEPS	33	5 mm BIOPSIE-ZANGEN	33
5 mm GRASPING & DISSECTING FORCEPS	34 - 35	5 mm FASS- & DISSEKTIONSZANGEN	34 - 35
10 mm GRASPING & DISSECTING FORCEPS	36 - 38	10 mm FASS- & DISSEKTIONSZANGEN	36 - 38
5 mm SCISSORS	39 - 40	5 mm SCHEREN	39 - 40
NEEDLE HOLDER	41	NADELHALTER	41
EASYKNOT SUTURING FORCEPS	42	EASYKNOT NAHTINSTRUMENT	42
SUTURE MATERIAL	43	NAHTMATERIAL	43
CLEANING & CARE	44	REINIGUNG & PFLEGE	44
LAPAROSCOPES & ACCESSORIES	45 - 47	LAPAROSKOPE & ZUBEHÖR	45 - 47

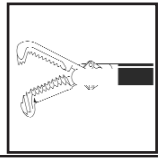



LITE-LINE Trokarhülse ohne Hahn
LITE-LINE trocar sleeve w/o stopcock

Innen-ø mit glattem Metallrohr mit Metallrohr mit Gewinde
Inside-ø with smooth metal sleeve with threaded metal sleeve

5,5 mm	JC-040-01	JC-040-04
11,5 mm	JC-040-02	JC-040-05
12,5 mm	JC-040-03	JC-040-06



LITE-LINE Trokarhülse mit Hahn
LITE-LINE trocar sleeve with stopcock

Innen-ø mit glattem Metallrohr mit Metallrohr mit Gewinde
Inside-ø with smooth metal sleeve with threaded metal tube

5,5 mm	JC-041-01	JC-041-04
11,5 mm	JC-041-02	JC-041-05
12,5 mm	JC-041-03	JC-041-06

LITE-LINE Silikondichtung
LITE-LINE silicone-seal

für 5,5 mm LITE-LINE-Trokarhülsen **JC-042-01**
for 5,5 mm LITE-LINE-trocar-sleeves

für 11,0+12,5 mm LITE-LINE-Trokarhülsen **JC-042-02**
for 11,0+12,5 mm LITE-LINE-trocar-sleeves



LITE-LINE Trokar, Dreikantspitze
LITE-LINE Trocar, pyramidal point

5,5 mm	JC-042-03
11,5 mm	JC-042-04
12,5 mm	JC-042-05

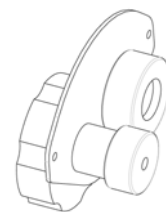

LITE-LINE Schiebe-Reduzierer
LITE-LINE sliding-reducer

11,0 mm - 5,5 mm **JC-042-06**

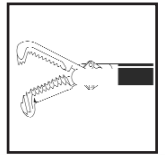

Trocarhülse mit Trompetenventil
Trocar Sleeve Trumpet Valve

Innen- \emptyset Inside- \emptyset	mit glattem Metallrohr with smooth metal sleeve	mit Metallrohr mit Gewinde with threaded metal sleeve
5,5 mm	JC-045-01	JC-045-11
11,0 mm	JC-045-02	JC-045-12
12,5 mm	JC-045-03	JC-045-13



Trocarhülse mit Klappenventil
Trocar Sleeve with automatic Valve

Innen- \emptyset Inner- \emptyset	mit glattem Metallrohr with smooth metal sleeve	mit Metallrohr mit Gewinde with threaded metal sleeve
5,5 mm	JC-046-01	JC-046-11
7,0 mm	JC-046-02	JC-046-12
11,0 mm	JC-046-03	JC-046-13
12,5 mm	JC-046-04	JC-046-14

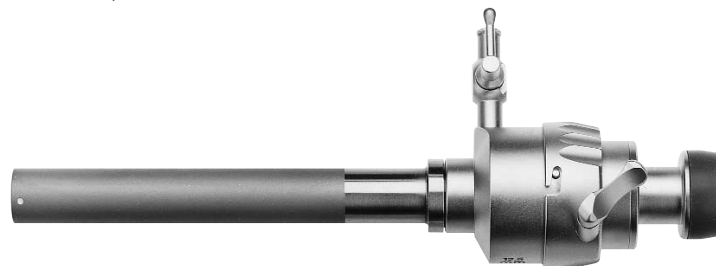

Automatik-Trocarhülse mit manuell bedienbarem Klappenventil
Automatic Trocar Sleeve with manual operated flap valve

Innen- \emptyset Inner- \emptyset	mit glattem Metallrohr with metal smooth sleeve	mit Metallrohr mit Gewinde with metal treaded sleeve
5,5 mm	JC-047-01	JC-047-11
7,0 mm	JC-047-02	JC-047-12
11,0 mm	JC-047-03	JC-047-13
12,5 mm	JC-047-04	JC-047-14

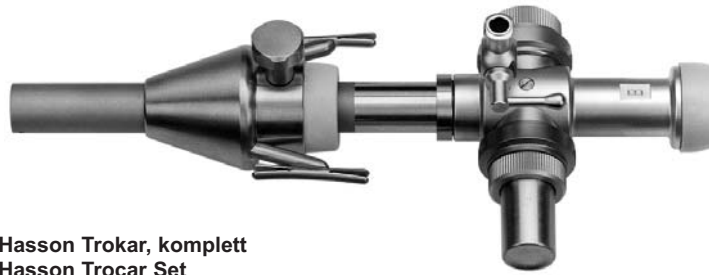
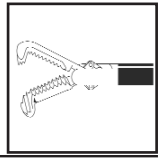

Hasson Trokar, komplett
Hasson Trocar Set

mit manuell
bedienb.

Klappenventil Innen-ø Inner-ø	mit Trompetenventil with Trumpet Valve	mit Klappenventil with Automatic Valve	with manual operated flap valve
5,5 mm	JC-048-01	JC-048-11	JC-048-21
11,0 mm	JC-048-02	JC-048-12	JC-048-22
12,5 mm	JC-048-03	JC-048-13	JC-048-23

Zubehör für Hasson-Trokar
Accessories for Hasson Cannula



Hasson Konus
Hasson Cone



Hasson Trokar-Stop
Hasson Fascial Holder



Stumpfer Dorn
Obturator

Aussen-ø Outside-ø	Hasson-Konus Hasson Cone	Stumpfer Dorn Obturator	Hasson-Trokar Stop Hasson-Fascial Holder
5,5 mm	JC-049-01	JC-049-11	JC-049-21
11,0 mm	JC-049-02	JC-049-12	JC-049-22
12,5 mm	JC-049-03	JC-049-13	JC-049-23

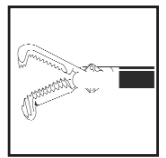

Zubehör für Trokarhülsen, AL 100 mm, andere Längen auf Anfrage
Accessories for trocar sleeve, WL 100 mm, further lengths available upon request

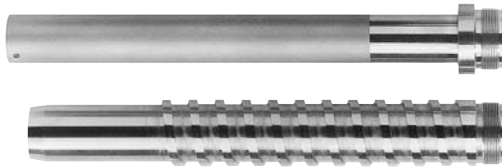

Innen- \emptyset Inside- \emptyset	Metalrohr glatt Smooth metal tube	Metallrohr mit Gewinde Threaded metal tube	Gummikappen 10 St./VE Sealing caps 10 pcs./pack	Ersatzdichtungen 10 St./VE O-Rings 10 pcs/pack
5,5 mm	JC-440-01	JC-440-11	JC-440-21	JC-440-31
7,0 mm	JC-440-02	JC-440-12	JC-440-22	JC-440-32
11,0 mm	JC-440-03	JC-440-13	JC-440-23	JC-440-33
12,5 mm	JC-440-04	JC-440-14	JC-440-24	JC-440-34

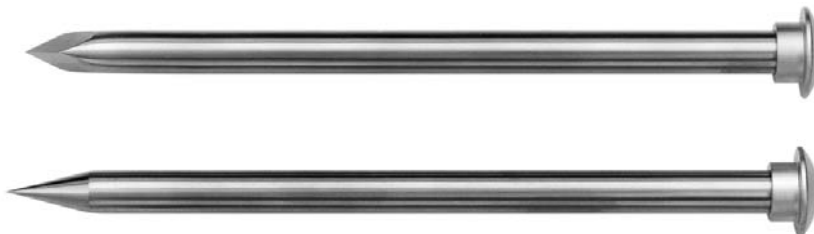

Trokar, Dreikantspitze
Trocar, pyramidal point

Aussen- \emptyset
Outside- \emptyset

5,5 mm	JC-049-41
7,0 mm	JC-049-42
11,0 mm	JC-049-43
12,5 mm	JC-049-44

Trokar, Kegelspitze
Trocar, conical point

Aussen- \emptyset
Outside- \emptyset

5,5 mm	JC-049-51
7,0 mm	JC-049-52
11,0 mm	JC-049-53
12,5 mm	JC-049-54

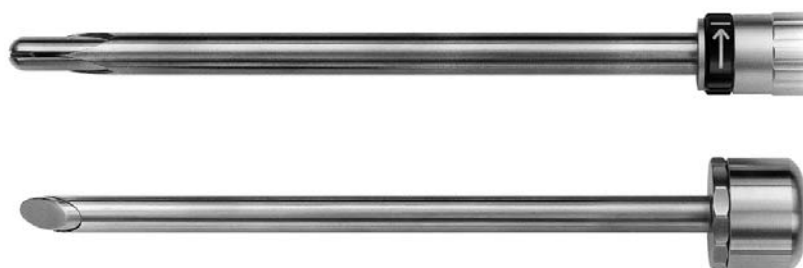

Sicherheitstrokar mit automatischem Spitzenschutz
Shielded Trocar with automatic tip cover

Aussen- \emptyset
Outside- \emptyset

5,5 mm	JC-049-61
10,5 mm Storz	JC-049-62
11,0 mm	JC-049-63
12,5 mm	JC-049-64

Veress Sicherheitstrokar
Veress shielded trocar

Aussen- \emptyset
Outside- \emptyset

5,5 mm	JC-049-71
11,0 mm	JC-049-72
12,5 mm	JC-049-73

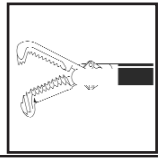

Reduzier-Hülse
Reducer-sleeve

Aussen- \emptyset Innen- \emptyset
Outside- \emptyset Inside- \emptyset

10,0 mm	-	5 mm	JC-140-01
11,0 mm	-	5 mm	JC-140-02
12,5 mm	-	5 mm	JC-140-03
12,5 mm	-	10 mm	JC-140-04
15,0 mm	-	5 mm	JC-140-05
15,0 mm	-	10 mm	JC-140-06
20,0 mm	-	15 mm	JC-140-07
20,0 mm	-	10 mm	JC-140-08

Dilations-Set mit Führungsstab
Dilation Set guide probe

Innen- \emptyset Aussen- \emptyset
Inside- \emptyset Outside- \emptyset

5,0 mm	-	10 mm	JC-141-01
5,0 mm	-	11 mm	JC-141-02
10,5 mm	-	15 mm	JC-141-03
10,5 mm	-	20 mm	JC-141-04



Klappreduzierer
Reducer-Adapter

Aussen- \emptyset Innen- \emptyset
Outside- \emptyset Inside- \emptyset

11,0 mm	-	5 mm	JC-142-01
12,5 mm	-	5 mm	JC-142-02



Reduzierer, kurz
Reducer, short

Aussen- \emptyset Innen- \emptyset
Outside- \emptyset Inside- \emptyset

11,0 mm	-	5 mm	JC-142-11
12,5 mm	-	5 mm	JC-142-12

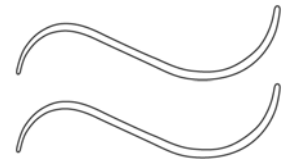

S-Retraktor, 2 Stück
S-retractor, set of 2

5,5 mm	JC-142-21
11,0 mm	JC-142-22



Veress Insufflations-Kanüle
Veress Insufflation-cannula



Arbeitslänge
Working length \emptyset 2-0 mm

80 mm	JC-143-01
100 mm	JC-143-02
120 mm	JC-143-03
150 mm	JC-143-04
170 mm	JC-143-05
200 mm	JC-143-06

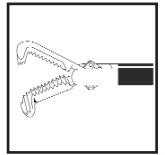

Adaptierbare Saug-/ Spülrohre für JC-030-04 / JC-030-05 / JC-030-06
Adaptable Suction-/Irrigation Tubes for JC-030-04 / JC-030-05 / JC-030-06



**Klappreduzierer
Reducer-Adapter**

Aussen-ø Arbeitslänge
Outside-ø Working Length

3 mm	330 mm	JC-030-01
5 mm	330mm	JC-030-02
10 mm	330 mm	JC-030-03



Saug-/ Spülhandgriff mit Trompetenventil
Single Trumpet Valve Handle

JC-030-04



Saug-/ Spülhandgriff mit
Doppeltrompetenventil, abnehmbar
ergonomisch Griffplatte
Double Trumpet Valve Handle with
detachable ergonomic handle plate

JC-030-05



Saug-/Spül- Pistolenhandgriff mit
wartungsfreiem 2-Wege Ventil
Pistol Handle with maintenance-free
2-way valve

JC-030-06

Adaptierbare Saug-/ Spülrohre für JC-030-11
Adaptable Suction-/Irrigation Tubes for JC-030-11



Aussen-ø Arbeitslänge
Outside-ø Working Length

3 mm	330 mm	JC-030-12
5 mm	330 mm	JC-030-13
10 mm	330 mm	JC-030-14



Wartungsfreies 2-Wege Ventil
mit Dreh adapter und LL-Anschluss
Maintenance-free 2-Way Valve
with rotating adapter and LL-connector

JC-030-11

Adaptierbare Injektion-/ Punktions-Kanüle für JC-030-11
Adaptable Injection-/Puncture Needle Tube for JC-030-11

Aussen-ø Arbeitslänge
Outside-ø Working Length

3 mm	330 mm	JC-030-15
------	--------	------------------

Injektions-/Punktions-Nadel, mit kleinem LL-Anschluss
Injection-/Puncture Needle, small-connector

Aussen-ø Arbeitslänge
Outside-ø Working Length

5 mm	330 mm	JC-030-16
5 mm	450 mm	JC-030-17

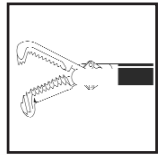

Saug-/Spülrohr mit zwei seitlichen Trompetenventilen, \varnothing 5 mm, AL 330 mm
Suction and Irrigation Tube with two lateral trumpet valves, \varnothing 5 mm, WL 330 mm

JC-030-21



Laserführung für JC-030-21
Laser Channel Insert for JC-030-21

JC-030-22



Skalpellhalter für JC-030-21
Blade Handle for JC-030-21

JC-030-23

Adaptierbare Klingen für Skalpellhalter JC-030-21 und JC-035-02
Adaptable blades for Blade Handles JC-030-21 and JC-035-02



Runde Klinge
Rounded blade

JC-030-24



Spitze Klinge, gerade
Pointed blade, straight

JC-030-25



Spitze Klinge, gebogen
Pointed blade, curved

JC-030-26

Bipolare Elektroden, Aussen- \varnothing 3 mm, AL 340 mm
Bipolar Electrodes, Outside- \varnothing 3 mm, WL 340 mm



V-Haken-Elektrode
V-hook-Electrode

JC-033-01



L-Haken-Elektrode
Right-angle-Electrode

JC-033-02



10 mm Nadel-Elektrode
10 mm Needle -Electrode

JC-033-03

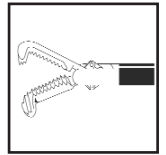

Saug-/Spülrohr mit zwei seitlichen Trompetenventilen, Aussen-ø 10 mm mit 5 mm Durchgangs-Trompetenventil, AL 330 mm
 Suction and Irrigation Tube, with two lateral trumpet valves, Outside-ø 10 with 5 mm instrument channel, WL 330 mm

JC-035-01

Hinweis:

Alle monopolen HF-Elektroden der Serie

JC-083-02/JC-083-04/JC-083-06/JC-093-08/JC-083-10/JC-083-12/JC-083-14 und JC-085-10 eignen sich hervorragend für den Einsatz mit dem Saug-/Spülrohr JC-035-01

All monopolar HF-electrodes of series

JC-083-02/JC-083-04/JC-083-06/JC-093-08/JC-083-10/JC-083-12/JC-083-14 and JC-085-10 are perfectly suited for use with the Suction-/Irrigation tube JC-035-01



Skalpellsalter, 5 mm, AL 380 mm
 Blade Handle, 5 mm WL 380 mm

JC-035-02

Adaptierbare Klengen siehe **JC-030-24 / JC-030-25 / JC-030-26**
 Adaptable blades refer to **JC-030-24 / JC-030-25 / JC-030-26**

Bipolare Elektroden, Aussen-ø 3 mm, AL 340 mm
 Bipolar Electrodes, Outside-ø 3 mm, WL 340 mm



J-Haken-Elektrode
J-Hook-Electrode

JC-035-03



Kuppel-Elektrode
Dome-Electrode

JC-035-06



L-Haken-Elektrode
Right-Angle-Electrode

JC-035-04



Teller-Elektrode
Plate-Electrode

JC-035-07



Spatel-Elektrode
Spatula-Electrode

JC-035-05

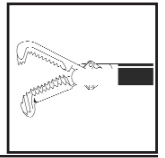

Modulare Saug-/Spülhandstücke mit HF-Anschluss und Drehadapter für adaptierbare monopolare HF-Elektroden
Modular Suction-/Irrigation handles with HF-connector and rotating adaptor for adaptable monopolar HF-electrodes



Handstück mit Durchflusshahn
Stop Cock Valve Handle

JC-080-01



Handstück mit 1
Trompetenventil
Single Trumpet Valve Handle

JC-080-02



Handstück mit 2-Wege Ventil
Two way Valve Handle

JC-080-03



Handstück mit 2 seitlichen Trompetenventilen
Double Trumpet Valve Handle

JC-080-04



Handstück mit Doppeltrompetenventil und abnehmbarer ergonomischer Griffplatte
Double Trumpet Valve Handle with detachable ergonomic handle plate

JC-080-05



Pistolengriff mit wartungsfreiem 2-Wege Ventil
Pistol Handle with maintenance free 2-way valve

JC-080-06

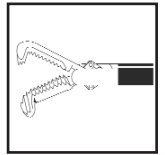

- ① Adaptierbare monopolare HF-Elektroden für modulare Handstücke der Serie
JC-080-01 / JC-080-02 / JC-080-03 / JC-080-04 / JC-080-05 und JC-080-06
 Adaptable monopolar HF-Electrodes for modular handles of series
JC-080-01 / JC-080-02 / JC-080-03 / JC-080-04 / JC-080-05 and JC-080-06

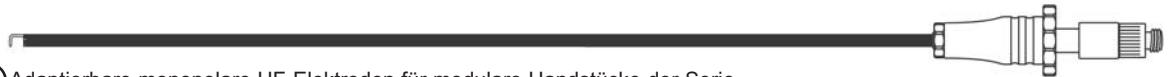

- ② Adaptierbare monopolare HF-Elektroden für modulare Handstücke der Serie
JC-080-01 / JC-080-02 / JC-080-03 / JC-080-04 / JC-080-05 und JC-080-06 mit beweglichem, isolierten Schaft
 Adaptable monopolar HF-Electrodes for modular handles of series
JC-080-01 / JC-080-02 / JC-080-03 / JC-080-04 / JC-080-05 and JC-080-06 with sliding insulation



1. Schritt
1. Step











2. Schritt
2. Step



3. Schritt
3. Step



- ③ Monopolare Elektroden mit HF-Anschluss
 Monopolare Electrodes with HF-connector

ø 5 mm	Arbeitslänge Working length	①	Arbeitslänge Working length	②	Arbeitslänge Working length	③
 Hakenelektrode, dünn Hook electrode, thin	330 mm 450 mm	JC-081-01 JC-081-02	330 mm 450 mm	JC-082-01 JC-082-02	330 mm 450 mm	JC-083-01 JC-083-02
 Hakenelektrode, dick Hook Electrode, thick	330 mm 450 mm	JC-081-03 JC-081-04	330 mm 450 mm	JC-082-03 JC-082-04	330 mm 450 mm	JC-083-03 JC-083-04
 Winkelelektrode Right Angle Electrode	330 mm 450 mm	JC-081-05 JC-081-06	330 mm 450 mm	JC-082-05 JC-082-06	330 mm 450 mm	JC-083-05 JC-083-06
 Spatel-Elektrode Spatula Electrode	330 mm 450 mm	JC-081-07 JC-081-08	330 mm 450 mm	JC-082-07 JC-082-08	330 mm 450 mm	JC-083-07 JC-083-08
 Knopf-Elektrode Ball Electrode	330 mm 450 mm	JC-081-09 JC-081-10	330 mm 450 mm	JC-082-09 JC-082-10	330 mm 450 mm	JC-083-09 JC-083-10
 Messer Elektrode Knife Electrode	330 mm 450 mm	JC-081-11 JC-081-12	330 mm 450 mm	JC-082-11 JC-082-12	330 mm 450 mm	JC-083-11 JC-083-12
 45° Nadel Elektrode 45° Needle Electrode	330 mm 450 mm	JC-081-13 JC-081-14	330 mm 450 mm	JC-082-13 JC-082-14	330 mm 450 mm	JC-083-13 JC-083-14
 Nadel Elektrode Needle Electrode	330 mm 450 mm	JC-081-15 JC-081-16	330 mm 450 mm	JC-082-15 JC-082-16	330 mm 450 mm	JC-083-15 JC-083-16
 Saug-/Spülrohr Suction-/Irrigation Tube	330 mm 450 mm	JC-081-17 JC-081-18	330 mm 450 mm	JC-082-17 JC-082-18	330 mm 450 mm	JC-084-17 JC-084-18

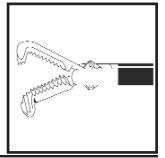

Guillotine Elektrode, monopolar, 5/330 mm
Guillotine Electrode, monopolar, 5/330 mm

JC-085-01

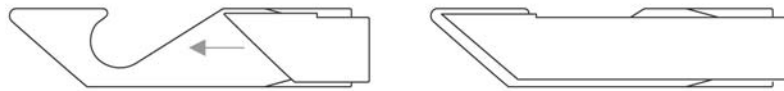

Messer
Knife

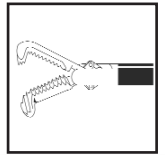

**Instrumentenseite
Instrument Side**

Für alle Instrumente mit männliche
monopolaren 4 mm Anschluss z. B.

For all instruments with male monopolar
4 mm connector, for example

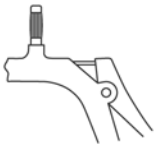

**MIC-Instrumente
MIS-Instruments**



**Laparoskopie-Elektroden
Laparoscopy electrodes**



**Monopolare Pinzetten
Monopolar forceps**



**Standard Instrumenten-Stecker
Standard instruments-connector**



**Sicherheits-Instrumenten-Stecker
Safety instrument-connector**

Einzigartige Sicherheitshülse - macht gewöhnliche 4 mm
Stecker berührsicher.
Unique safety sleeve-makes conventional 4 mm connectors
touch-safe

- Fester Halt am Instrument durch vergoldete Lamellenkontakte
- Erfüllt die IEC 601 Anforderungen
- Für alle gebräuchlichen Generatoren
- Instrumentenseite-Stecker *grau*
- Generatorseite-Stecker *schwarz*

- Firm hold at the instrument due to gold-plated spring contacts
- Meets IEC 601 requirements
- For all common ESU's
- Instrument side - connector *grey*
- Generator side-connector *black*

**Generatorseite
Generator side**

Martin, Berchtold, Erbe, T-Serie
Martin, Berchtold, Erbe, T-Series



**mit Standard Instrumenten-Stecker
with standard instrument-connector** ①

Länge
length
3000 mm **JC-180-01**
5000 mm **JC-180-02**

**mit Sicherheits-Instrumenten-Stecker
with Safety instrument-connector** ②

Länge
length
3500 mm **JC-180-03**

Erbe ACC/ICC-Serie
Erbe ACC/ICC-Series



**mit Standard Instrumenten-Stecker
with standard instrument-connector** ①

Länge
length
3000 mm **JC-180-04**
5000 mm **JC-180-05**

**mit Sicherheits-Instrumenten-Stecker
with Safety instrument-connector** ②

Länge
length
3500 mm **JC-180-06**

US-amerikanische Generatoren
US-American ESU's

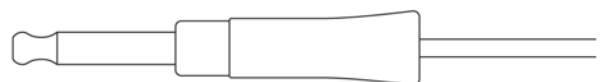

**mit Standard Instrumenten-Stecker
with standard instrument-connector** ①

Länge
length
3000 mm **JC-180-07**
5000 mm **JC-180-08**

**mit Sicherheits-Instrumenten-Stecker
with Safety instrument-connector** ②

Länge
length
3500 mm **JC-180-09**

“Wound Closure” Instrument
Wound Closure Forceps

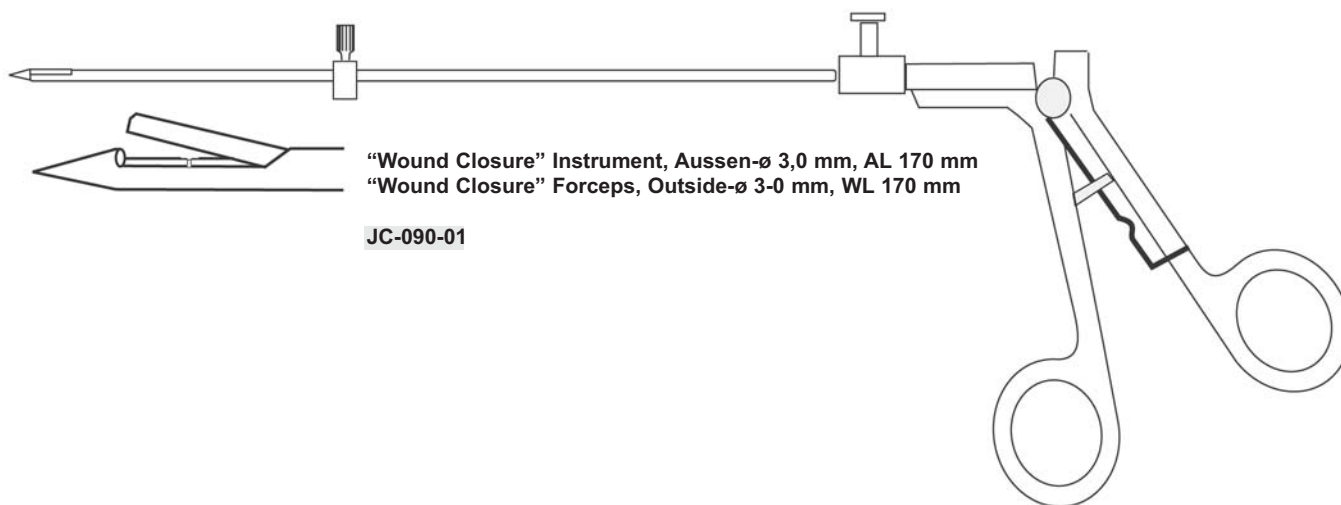
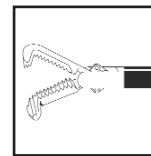

“Wound Closure” Instrument, Aussen- \varnothing 3,0 mm, AL 170 mm
“Wound Closure” Forceps, Outside- \varnothing 3-0 mm, WL 170 mm

JC-090-01

Vorteile:

- Reduziert oder vermeidet die Möglichkeit einer Hernie durch den Trocar, klaffende Wunden oder Blutungen.
- Vielfältige Anwendungsmöglichkeiten bei kontrolliertem Einführen sowie Tiefenregulierung durch Distanzhalter.
- Einfache Handhabung, speziell bei fettleibigen Patienten.
- Ein wiederverwendbares Qualitätsinstrument.

Advantages:

- Reduce or eliminate the possibility of trocar site hernia, wound dehiscence or bleeding.
- Multiple Applications with Controlled Entry and Depth Safety Stopper.
- Easy to Use, especially on obese patients.
- Quality Reusable Instrument.

Anwendung:

Das Nahtmaterial mittig mit dem Maulteil greifen. Der Chirurg platziert das Instrument mit dem Nahtmaterial direkt neben der Trocarhülse. Dieser Vorgang sollte nur unter Sicht durchgeführt werden. Es ist nötig, dass eine entsprechende Länge des Nahtmaterials unter dem Peritoneum verbleibt, damit dieses auf der gegenüberliegenden Trocar-Seite wieder einfach zu fassen und herausziehen ist.

Wenn das Nahtmaterial zufriedenstellend eingeführt ist, wird dieses unter dem Peritoneum zurückgelassen (1).

Danach wird das Instrument herausgezogen und auf der gegenüberliegenden Trocar-Seite wieder eingeführt (2). Fassen Sie wieder das Nahtmaterial mit dem Instrument und ziehen Sie dieses heraus. Danach das Abdomen im normalen Verfahren schliessen.

Technique:

Place suture in jaw near the middle of the suture length. Surgeon will place instrument (with suture) beneath level of skin full thickness incorporating posterior fascia directly adjacent to trocar cannula. This technique should be performed under laparoscopic vision. It is necessary to have an adequate length of suture in the peritoneal cavity so it can be easily retrieved and extracted when the instrument is reintroduced on the opposite side of trocar site.

Once the suture is introduced satisfactorily it is dropped (1) and instrument is extracted and reintroduced on opposite side (2). Suture is re-grasped and extracted with instrument incorporating all tissue layers except skin on removal. Abdominal wall is then closed in normal fashion.

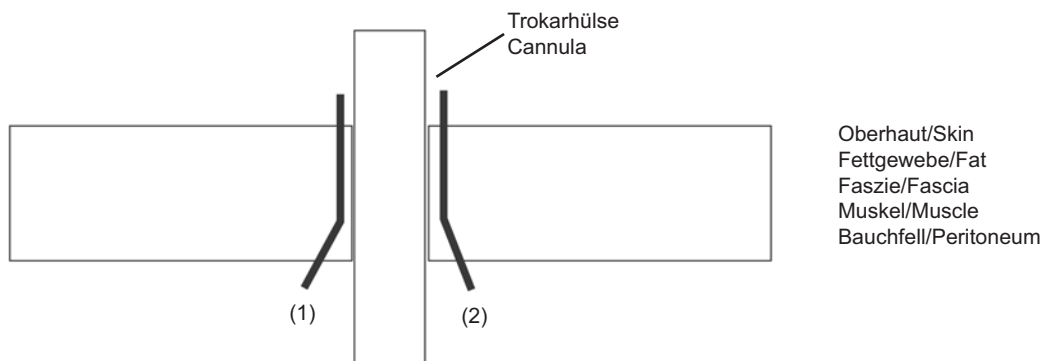

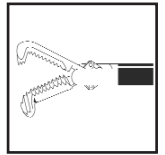

Applikator für Endo-Ligatur
Endo-Ligature Applicator

JC-090-01

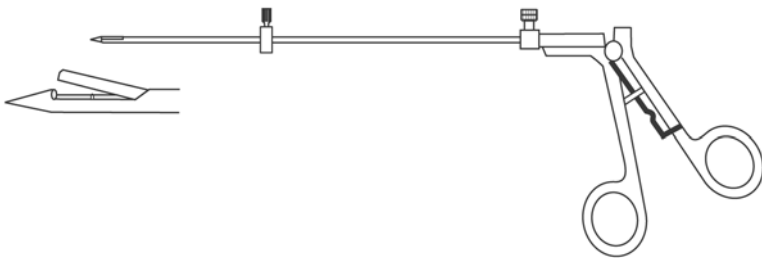

"Wound closure" Instrument, \varnothing 3 mm, AL 170 mm
"Wound closure" Forceps, \varnothing 3 mm, WL 170 mm

JC-091-01

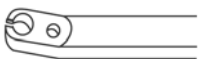

Knotenschieber \varnothing 5 mm, offenes Fadenloch
Knot Pusher \varnothing 5 mm, suture opening

Arbeitslänge
Working Length

330 mm	JC-092-01
450 mm	JC-092-02

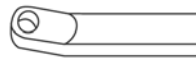

Knotenschieber \varnothing 5 mm, geschlossenes Fadenloch
Knot Pusher \varnothing 5 mm, without suture opening

Arbeitslänge
Working Length

330 mm	JC-092-11
450 mm	JC-092-12



Knotenschieber mit Schlitz, \varnothing 5 mm
Knot Pusher with slot \varnothing 5 mm

330 mm	JC-093-01
450 mm	JC-093-02



Taststab graduert, \varnothing 5 mm
Palpation Probe graduated, \varnothing 5 mm

330 mm	JC-094-01
450 mm	JC-094-02



Myom-Heber 5 mm
Myoma Screw 5 mm

Arbeitslänge Working Length	
330 mm	JC-095-01
450 mm	JC-095-02

Myom-Heber 10 mm
Myoma Screw 10 mm

Arbeitslänge Working Length	
330 mm	JC-095-11
450 mm	JC-095-12

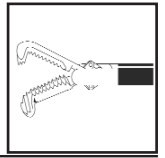

Endo-Saug-/Spülhandgriff
Endo-Suction-/Irrigation handle

JC-096-01

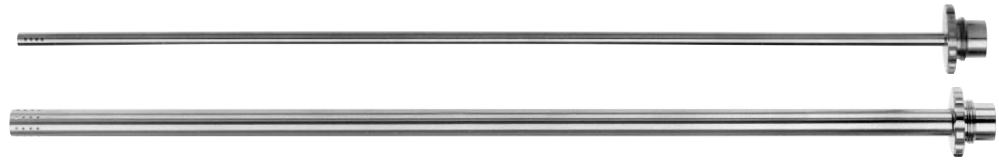

Endo Saug-/Spülrohre, AL 330 mm, für JC-096-01
Endo Suction-/Irrigation tubes, WL 330 mm, for JC-096-01

5 mm	JC-096-02
10 mm	JC-096-03



Fasszangen mit Federgriff, ø 5 mm, AL 330 mm
Grasping forceps with spring handle, ø 5 mm, WL 330 mm

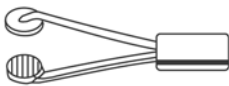

Darmgreifer
Bowel Forceps

JC-097-01

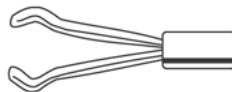

Atraumatische Fasszange
Atraumatic Grasping Forceps

JC-097-02

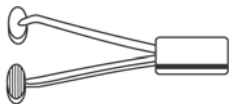

T-förmige Fasszange
T-Pattern Forceps

JC-097-03



Quadrat-förmige Fasszange
Square-Pattern Forceps

JC-097-04



Ring-förmige Fasszange
Ring-Pattern Forceps

JC-097-05



Fächer-Retraktor, ø 5 mm, AL 340 mm
Fan Retractor, ø 5 mm, WL 340 mm

JC-099-01

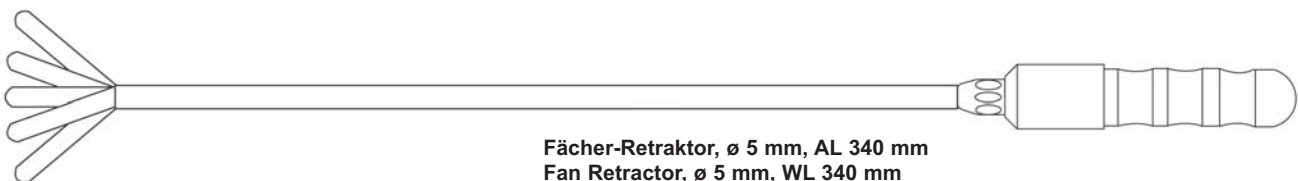

Fächer-Retraktor, ø 5 mm, AL 340 mm
Fan Retractor, ø 5 mm, WL 340 mm

JC-099-02

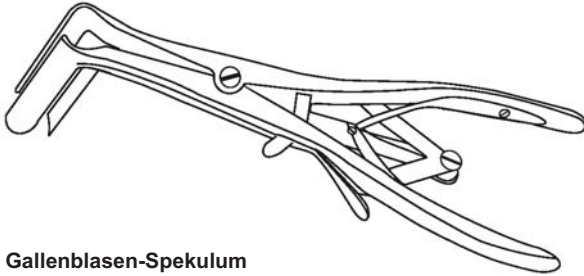
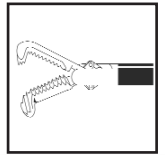

Gallenblasen-Spekulum
mit 3 Blättern, AL 55 mm
Speculum with 3 blades
for extraction of Gall Bladder, WL 55 mm

JC-099-03

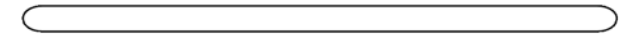

Kunststoff-Styler für operative Cholangiographie, AL 330 mm
Cholangiography Probe, radiolucent, WL 330 mm

ø 11,0 mm	JC-099-04
ø 12,5 mm	JC-099-05

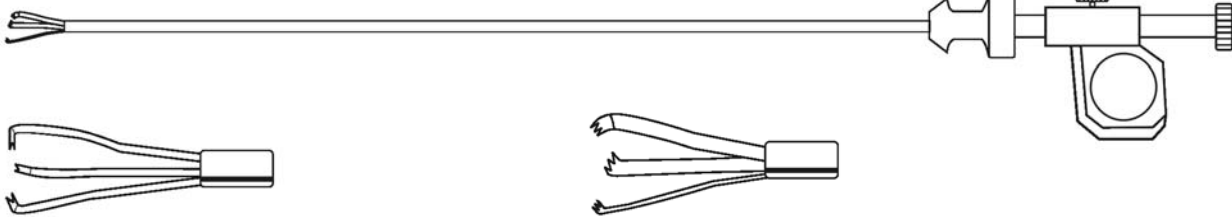

3-armiger aggressiver Greifer, 5 mm, AL 330 mm
Aggressive 3 Prong Grasper, 5 mm, WL 330 mm

JC-099-06

Allis 3-armiger Greifer, 5 mm, AL 330 mm
Allis 3 Prong Grasper, 5 mm, WL 330 mm

JC-099-07

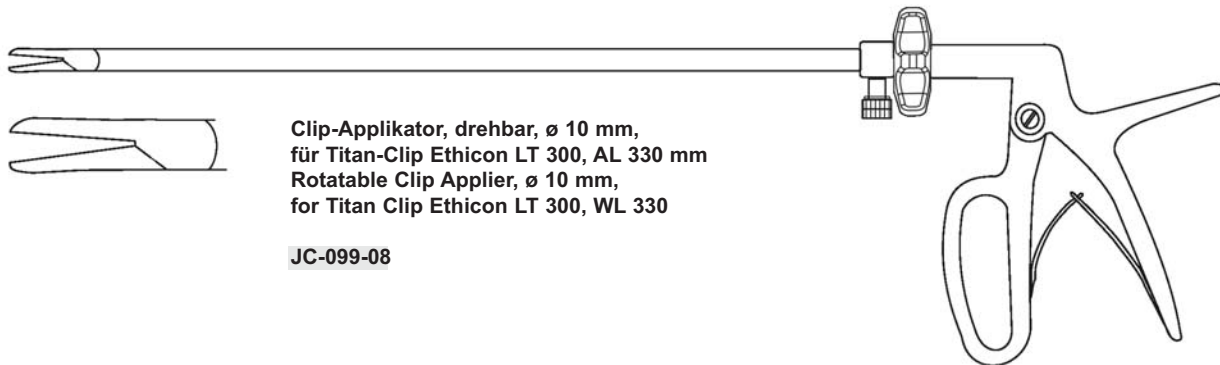

Clip-Applikator, drehbar, ø 10 mm,
für Titan-Clip Ethicon LT 300, AL 330 mm
Rotatable Clip Applier, ø 10 mm,
for Titan Clip Ethicon LT 300, WL 330

JC-099-08

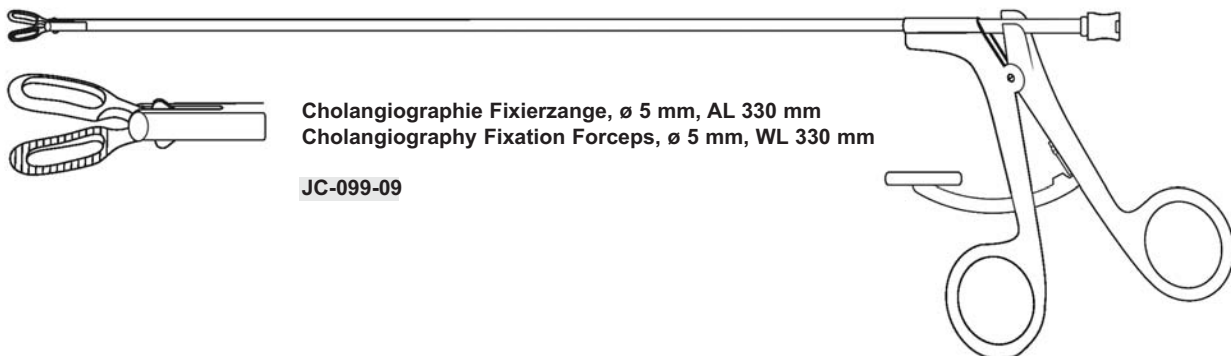

Cholangiographie Fixierzange, ø 5 mm, AL 330 mm
Cholangiography Fixation Forceps, ø 5 mm, WL 330 mm

JC-099-09

Bipolare Zangen 5 mm, starr, mit Spülkanal
Bipolar Forceps 5 mm, rigid, with cleaning port

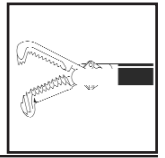

Bipolare Koagulationszange, mit gewelltem Steg
Bipolar coagulation forceps, with rippled bar

Arbeitslänge
Working length

330 mm	JC-070-01
450 mm	JC-070-02

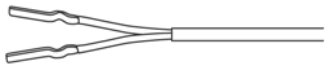

Bipolare Koagulationszange, 3 mm Maul
Bipolar coagulation forceps, 3 mm jaw

Arbeitslänge
Working length

330 mm	JC-070-03
450 mm	JC-070-03



Bipolare Koagulationszange, 1 mm Maul
Bipolar coagulation forceps, 1 mm jaw

Arbeitslänge
Working length

330 mm	JC-070-05
450 mm	JC-070-05

Alle Zangen mit Flachstecker
All Bipolar forceps with flat plug

Mikro-Bipolare-Zange 3 mm, zerlegbar
 Micro-Bipolar-Forceps 3 mm, detachable

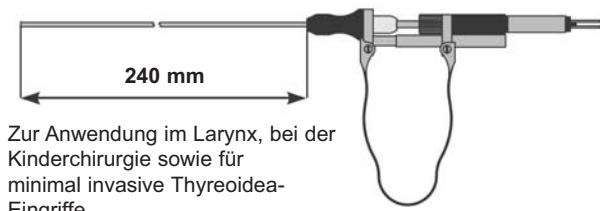
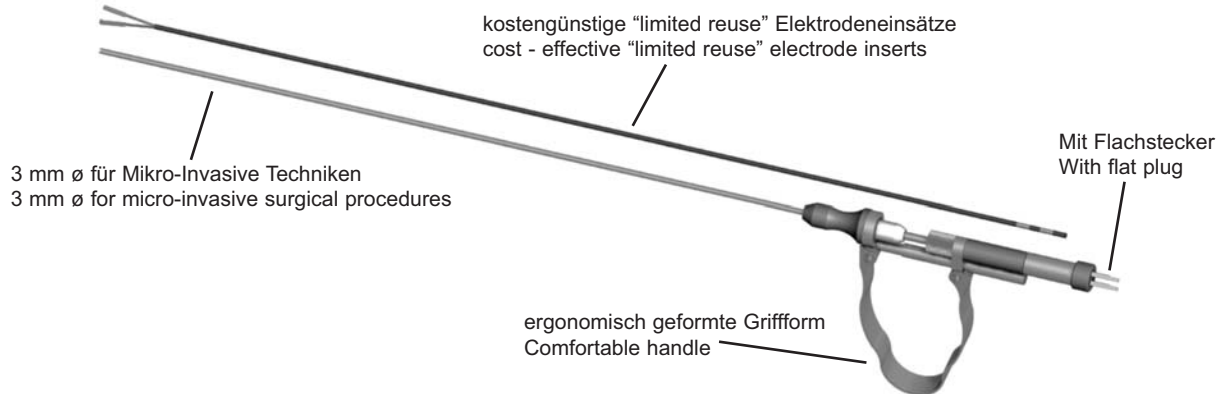
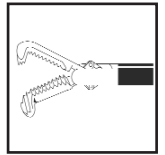

Zur Anwendung im Larynx, bei der Kinderchirurgie sowie für minimal invasive Thyreoidea-Eingriffe
 For use in the larynx, for paediatric surgery and for minimally invasive thyroid gland surgery.

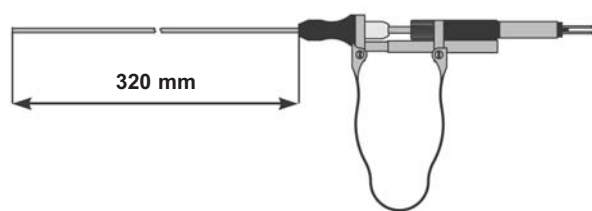

Zur Anwendung in der Mikro-Laparoskopie
 For use in micro-laparoscopy.



Bipolare Koagulations-Fasszange, komplett
Bipolar coagulation grasping forceps, complete

Arbeitslänge
 Working length
 240 mm **JC-071-01**
 320 mm **JC-071-02**



Bipolare Mikro-Koagulations-Fasszange gerade, komplett
Bipolar coagulation micro-grasping forceps, straight, complete

Arbeitslänge
 Working length
 240 mm **JC-071-11**
 320 mm **JC-071-12**



Bipolare Mikro-Koagulations-Fasszange gebogen, komplett
Bipolar coagulation micro-grasping forceps, curved, complete

Arbeitslänge
 Working length
 240 mm **JC-071-21**
 320 mm **JC-071-22**



Bipolarer Koagulations-Fasszange-Einsatz
Bipolar coagulation grasping forceps insert

Arbeitslänge
 Working length
 240 mm **JC-071-31**
 320 mm **JC-071-32**
 320 mm **JC-071-32**

Bipolare Mikro-Koagulations-Fasszange-Einsatz
Bipolar micro coagulation grasping forceps insert

Arbeitslänge Working length	Gerade Straight	Gebogen Curved
240 mm	JC-071-41	JC-071-51
320 mm	JC-071-42	JC-071-52



Ersatzrohr
Spare shaft

Arbeitslänge
 Working length
 240 mm **JC-071-61**
 320 mm **JC-071-62**

U-Griff allein, für alle Rohrlängen mit Flachstecker
U-shape handle only, for all tube lengths, with flat plug

JC-071-63

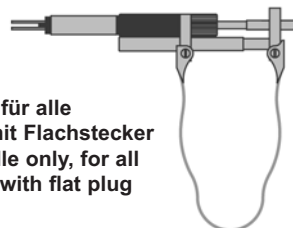

Ersatzdichtung
Spare seal

JC-071-64



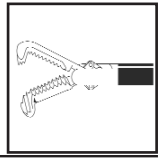

Wiederverwendbares Instrument für den Einsatz in der Laparoskopie zum Greifen und Schneiden von Gewebe bei gleichzeitiger bipolarer Koagulation. Generator-Spezifikation: Dieses Instrument wurde zum Anschluss an den bipolaren Ausgang von HF-Generatoren entwickelt. Die maximal zulässige Leistung beträgt 60 Watt.

Reusable instrument for use in laparoscopy for grasping and cutting tissue during bipolar coagulation. Generator Specification: This instrument has been designed for connection to the bipolar output of electro-surgical generators. The maximum power output shall not exceed 60 Watts.



Bequeme Handhabung

Die Elektrode ist um 360° drehbar, wodurch sie jederzeit in die gewünschte Position gebracht werden kann. Beim Schliessen erfolgt kein Zurückweichen des Arbeitendes. Dadurch ist ein punktgenaues Fassen des zu koagulierenden Gewebes möglich.

Comfortable Handling

The electrode can be rotated 360° for accurate jaw orientation. There is no receding of the jaw when closing. This allows precise grasping and coagulation of the tissue.

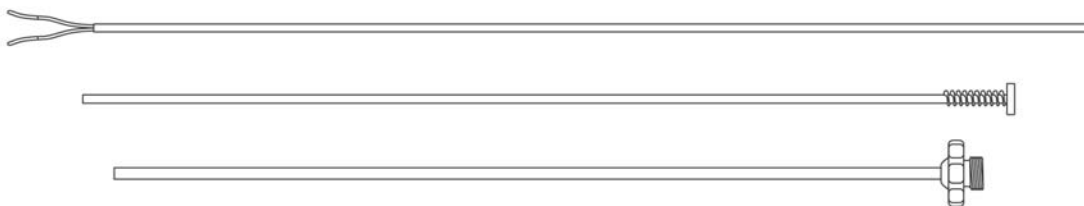
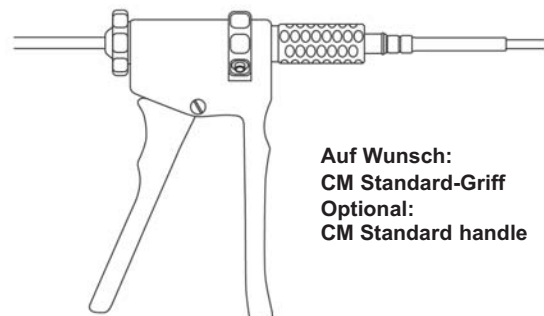

Hygiene und Wirtschaftlichkeit

Die Zange ist leicht zerlegbar. Dadurch ist es auch möglich, sonst nur schwer zugängliche Stellen zuverlässig zu reinigen. Durch den modularen Aufbau des Instruments sind alle Teile einzeln austauschbar. Dies erhöht die Reparaturfreundlichkeit und ermöglicht den Einsatz verschiedener Elektroden im selben, ergonomischen Handgriff.

Hygiene and Cost Effectiveness

The forceps are easily detachable. This allows to reliably clean even highly unaccessible areas. Because of it's modular design, all parts are interchangeable and therefore easy to repair. The various electrodes can be all used in the same, ergonomically designed handle.

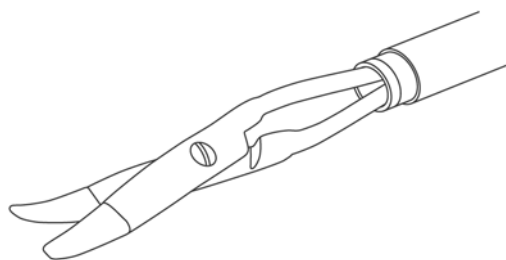
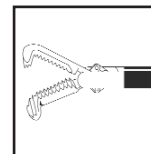

Bipolare Schere

Die neuentwickelte, wiederverwendbare Scherenelektrode für die Laparoskopie ermöglicht Dissektion und Schneiden bei gleichzeitiger bipolarer Koagulation. Ein Instrumentenwechsel ist nicht mehr notwendig.

Bipolar Scissors

The new, reusable bipolar curved scissors electrode for laparoscopy provides the ability to dissect, cut and coagulate at the same time. Changing the instrument is no longer necessary.

Modulare bipolare Zangen und Schere, komplett
Modular bipolar forceps and Scissors, complete

Elektroden allein
Electrodes only

Bipolare Zange mit gewelltem Steg
Bipolar forceps with rippled bar

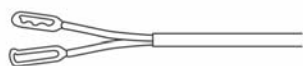

Mit CM Ringgriff		Mit Standardgriff	
With CM ring handle		With standard handle	
200 mm	JC-072-01	200 mm	JC-073-01
340 mm	JC-072-02	340 mm	JC-073-02
450 mm	JC-072-03	450 mm	JC-073-03

Arbeitslänge	
Working length	
200 mm	JC-074-01
340 mm	JC-074-02
450 mm	JC-074-03

Feine bipolare Zange, 1 mm Maul
Fine bipolar forceps, 1 mm jaw



Mit CM Ringgriff		Mit Standardgriff	
With CM ring handle		With standard handle	
200 mm	JC-072-04	200 mm	JC-073-04
340 mm	JC-072-05	340 mm	JC-073-05
450 mm	JC-072-06	450 mm	JC-073-06

Arbeitslänge	
Working length	
200 mm	JC-074-04
340 mm	JC-074-05
450 mm	JC-074-06

Bipolare Zange, 3 mm Maul
Bipolar forceps, 3 mm jaw



Mit CM Ringgriff		Mit Standardgriff	
With CM ring handle		With standard handle	
200 mm	JC-072-07	200 mm	JC-073-07
340 mm	JC-072-08	340 mm	JC-073-08
450 mm	JC-072-09	450 mm	JC-073-09

Arbeitslänge	
Working length	
200 mm	JC-074-07
340 mm	JC-074-08
450 mm	JC-074-09

Bipolare Fasszange, gerieftes Maul
Bipolar grasping forceps, serrated jaw



Mit CM Ringgriff		Mit Standardgriff	
With CM ring handle		With standard handle	
200 mm	JC-072-10	200 mm	JC-073-10
340 mm	JC-072-11	340 mm	JC-073-11
450 mm	JC-072-12	450 mm	JC-073-12

Arbeitslänge	
Working length	
200 mm	JC-074-10
340 mm	JC-074-11
450 mm	JC-074-12

Bipolare Scheren, gebogen
Bipolar scissors, curved



Mit CM Ringgriff		Mit Standardgriff	
With CM ring handle		With standard handle	
200 mm	JC-072-13	200 mm	JC-073-13
340 mm	JC-072-14	340 mm	JC-073-14
450 mm	JC-072-15	450 mm	JC-073-15

Arbeitslänge	
Working length	
200 mm	JC-074-13
340 mm	JC-074-14
450 mm	JC-074-15

Bipolarer Dissektor Maryland
Bipolar dissector Maryland



Mit CM Ringgriff		Mit Standardgriff	
With CM ring handle		With standard handle	
200 mm	JC-072-16	200 mm	JC-073-16
340 mm	JC-072-17	340 mm	JC-073-17
450 mm	JC-072-18	450 mm	JC-073-18

Arbeitslänge	
Working length	
200 mm	JC-074-16
340 mm	JC-074-17
450 mm	JC-074-18

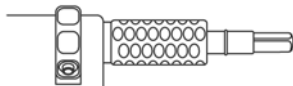
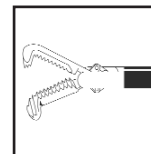

Kompatibilität

Die Zange ist in Verbindung mit dem entsprechenden Anschlusskabel kompatibel mit den meisten handelsüblichen Generatoren mit einer maximalen Leistung von 60 Watt. Durch den Einsatz eines Adapters kann sie auch mit einem bipolaren-Standard-Pinzettenkabel angeschlossen werden.

Compatibility

The forceps in conjunction with the respective connection cable is compatible with the bipolar output of most electro-surgical generators not exceeding 60 Watts. An adapter can be used in order to connect a standard bipolar forceps cable.

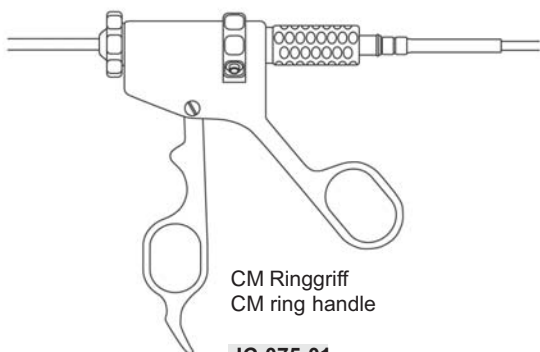

CM Ringgriff
 CM ring handle

JC-075-01

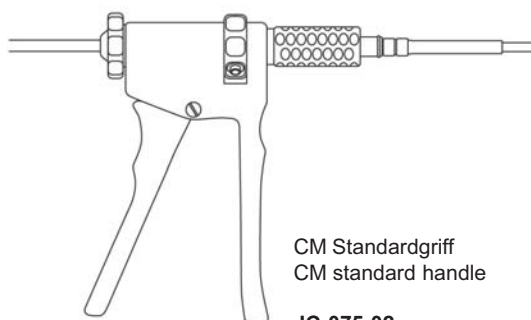

CM Standardgriff
 CM standard handle

JC-075-02



Aussenrohr
Outer tube

Arbeitslänge
 Working length
 200 mm **JC-075-10**
 340 mm **JC-075-11**
 450 mm **JC-075-12**



Innenrohr
Inner tube

Arbeitslänge
 Working length
 200 mm **JC-075-20**
 340 mm **JC-075-21**
 450 mm **JC-075-22**



Adapter mit Flachstecker
Adapter with flat plug

JC-075-30

Bipolarkabel, Länge 3000 mm, direkter Anschluss an den Griff
Bipolar cables, length 3000 mm, direct connection to handle

Geräteseitig 2 Bananen-Stecker / Generator end 2 banana plug	JC-075-40
Geräteseitig Valleylab-Stecker / Generator end Valleylab plug	JC-075-41
Geräteseitig Martin-Stecker / Generator end Martin plug	JC-075-42
Geräteseitig Erbe-Stecker / Generator end Erbe plug	JC-075-43

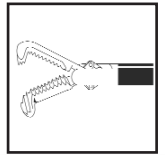

Instrumente
Instruments

AUTOCLAVE
134 C / 273



Bipolar Silikonkabel mit Universalstecker
Bipolar Silicon cables with Universal plug

Universaler bipolarer Stecker für Instrumente mit Flachstecker
Universal bipolar plug fitting to instruments with flat connector

Vorteile

- hochwertige Silikonkabel
- glatte Oberfläche, leicht zu reinigen
- Latexfrei

Advantages

- high-quality silicone cable
- smooth surface, easy to clean
- free of latex

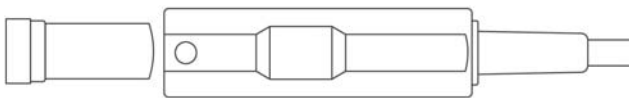

Bipolare Silikonkabel mit Sicherheits-Stecker
Bipolare Silicon cables with Safety plug

Vorteile

- vollständige Berührungssicherheit
- geringes Gewicht
- hochwertiges Silikonkabel
- glatte Oberfläche, leicht zu reinigen
- Latexfrei

Advantages

- complete touch-safety
- light weight
- high-quality silicone cable
- smooth surface, easy to clean
- free of Latex

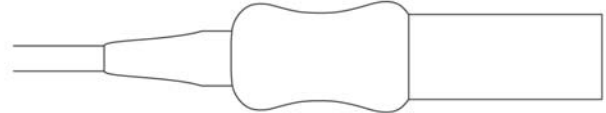
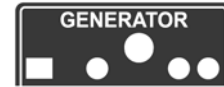

Erbe / Select / Storz / Wolf

Länge Length	Universal-Stecker Universal plug	Sicherheits-Stecker Safety plug
3000 mm	JC-076-01	JC-076-11
5000 mm	JC-076-02	JC-076-12

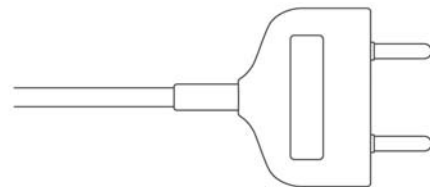

Valleylab

Länge Length	Universal-Stecker Universal plug	Sicherheits-Stecker Safety plug
3000 mm	JC-076-03	
4500 mm		JC-076-14
5000 mm	JC-076-05	

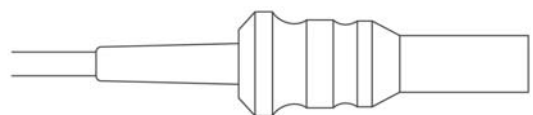

Martin / Berchtold / Aesculap

Länge Length	Universal-Stecker Universal plug	Sicherheits-Stecker Safety plug
3000 mm	JC-076-06	JC-076-16
5000 mm	JC-076-07	JC-076-17

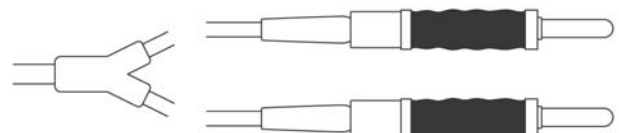

2 Bananenstecker
2 banana plug

Länge Length	Universal-Stecker Universal plug	Sicherheits-Stecker Safety plug
3000 mm	JC-076-08	JC-076-18
5000 mm	JC-076-09	JC-076-19

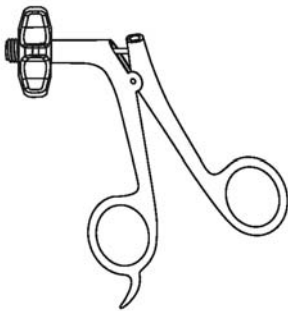
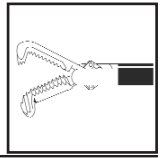

Metallgriff
Metal handle

JC-100-01

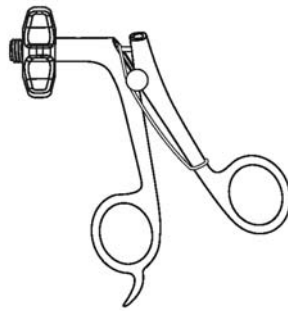

Metallgriff mit Feder
Metal handle with spring

JC-100-02

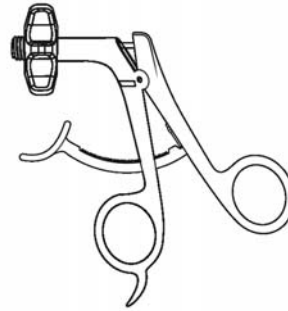

Metallgriff mit Raste
vorwärts öffnend
Metal handle
with front ratchet

JC-100-03



Isolierter Metallgriff
mit HF-Anschluss
Insulated metal handle
with HF-connector

JC-100-05



Carbon Griff,
ohne HF-Anschluss
Carbon handle,
without HF-connector

JC-100-11



Carbon Griff mit Feder,
ohne HF-Anschluss
Carbon handle with spring,
without HF-Connector

JC-100-12



Carbon Griff mit Raste,
ohne HF-Anschluss
Carbon handle with ratchet
without HF-Connector

JC-100-13



Carbon Griff mit mit aktivierbarer/
deaktivierbarer Raste
ohne HF-Anschluss
Carbon handle with activating/
deactivating ratchet
without HF-Connector

JC-100-14



Carbon Griff,
mit HF-Anschluss
Carbon handle,
with HF-connector

JC-100-21



Carbon Griff mit Feder,
mit HF-Anschluss
Carbon handle with spring,
with HF-Connector

JC-100-22

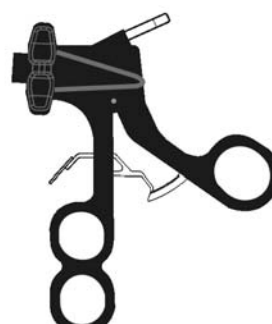

Carbon Griff mit Raste,
mit HF-Anschluss
Carbon handle with ratchet
with HF-Connector

JC-100-23

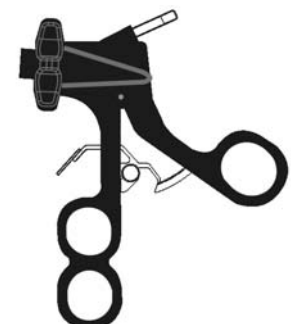

Carbon Griff mit mit aktivierbarer/
deaktivierbarer Raste
mit HF-Anschluss
Carbon handle with activating/
deactivating ratchet
with HF-Connector

JC-100-24

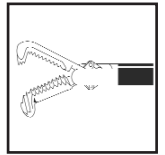

Metallschaft mit Schaftmutter
Metal Shaft with shaft knob

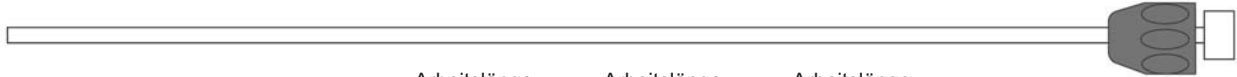

	Arbeitslänge Working Length 220 mm	Arbeitslänge Working Length 330 mm	Arbeitslänge Working Length 450 mm
∅ 5 mm	JC-200-01	JC-200-11	JC-200-21
∅ 10-5 mm	JC-200-02	JC-200-12	JC-200-22
∅ 10 mm	JC-200-03	JC-200-13	JC-200-23

Metallschaft mit Reinigungs-Anschluss und Schaftmutter
Metal Shaft with cleaning port and shaft knob

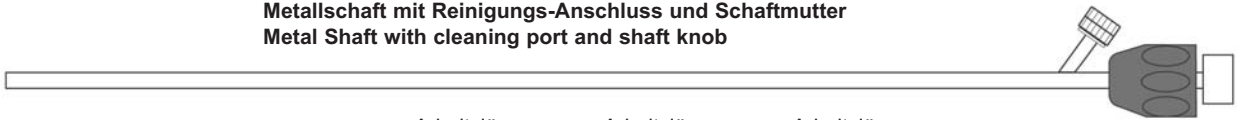

	Arbeitslänge Working Length 220 mm	Arbeitslänge Working Length 330 mm	Arbeitslänge Working Length 450 mm
∅ 5 mm	JC-201-01	JC-201-11	JC-201-21
∅ 10-5 mm	JC-201-02	JC-201-12	JC-201-22
∅ 10 mm	JC-201-03	JC-201-13	JC-201-23

Isolierter Schaft mit Schaftmutter
Insulated Shaft with knob



	Arbeitslänge Working Length 220 mm	Arbeitslänge Working Length 330 mm	Arbeitslänge Working Length 450 mm
∅ 5 mm	JC-202-01	JC-202-11	JC-202-21
∅ 10-5 mm	JC-202-02	JC-202-12	JC-202-22
∅ 10 mm	JC-202-03	JC-202-13	JC-202-23

Isolierter Schaft mit Reinigungs-Anschluss und Schaftmutter
Insulated Shaft with cleaning port and shaft knob

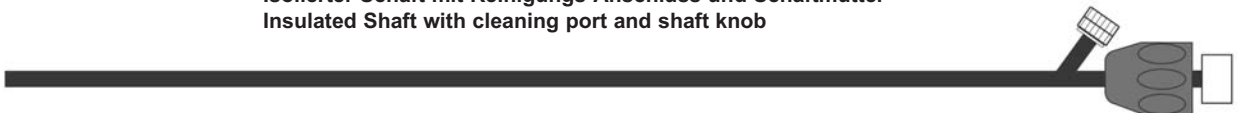

	Arbeitslänge Working Length 220 mm	Arbeitslänge Working Length 330 mm	Arbeitslänge Working Length 450 mm
∅ 5 mm	JC-203-01	JC-203-11	JC-203-21
∅ 10-5 mm	JC-203-02	JC-203-12	JC-203-22
∅ 10 mm	JC-203-03	JC-203-13	JC-203-23



Schaftmutter
Shaft Knob

∅ 5 mm	JC-200-50
∅ 10 mm	JC-200-51

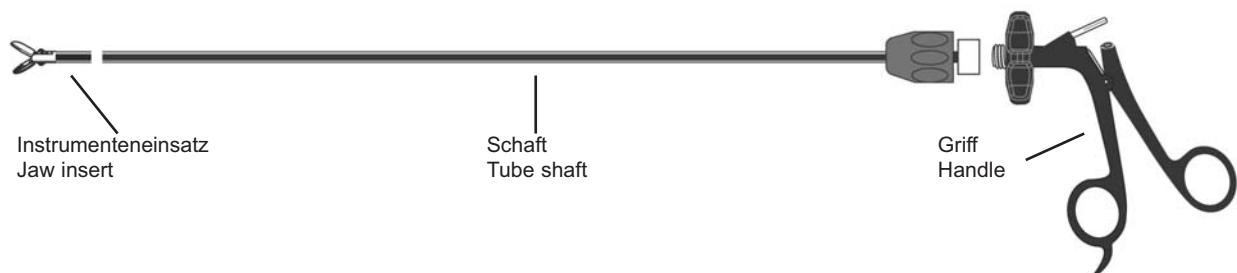
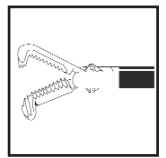

Fasszange, spitz
Grasping forceps, pointed

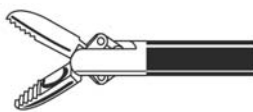

Arbeitslänge Working Length	Instr. Einsatz Jaw Insert	Schaft Tube shaft	Griff Handle	Komplett complete
220 mm	JC-500-01	JC-202-01	JC-100-05	JC-505-01
330 mm	JC-500-02	JC-202-11	JC-100-05	JC-505-02
450 mm	JC-500-03	JC-202-21	JC-100-05	JC-505-03

Lange Delphin-Fasszange
Long Delphin grasping forceps

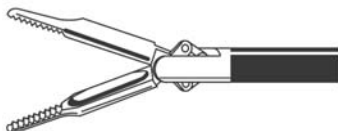

Arbeitslänge Working Length	Instr. Einsatz Jaw Insert	Schaft Tube shaft	Griff Handle	Komplett complete
220 mm	JC-500-04	JC-202-01	JC-100-05	JC-505-04
330 mm	JC-500-05	JC-202-11	JC-100-05	JC-505-05
450 mm	JC-500-06	JC-202-21	JC-100-05	JC-505-06

Kurze Delphin-Fasszange
Short Delphin grasping forceps

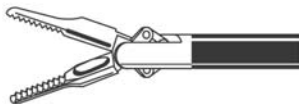

Arbeitslänge Working Length	Instr. Einsatz Jaw Insert	Schaft Tube shaft	Griff Handle	Komplett complete
220 mm	JC-500-07	JC-202-01	JC-100-05	JC-505-07
330 mm	JC-500-08	JC-202-11	JC-100-05	JC-505-08
450 mm	JC-500-09	JC-202-21	JC-100-05	JC-505-09

Lange Fasszange mit Löffel
Long grasping forceps with spoon

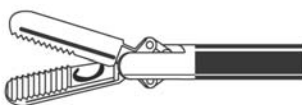

Arbeitslänge Working Length	Instr. Einsatz Jaw Insert	Schaft Tube shaft	Griff Handle	Komplett complete
220 mm	JC-500-10	JC-202-01	JC-100-05	JC-505-10
330 mm	JC-500-11	JC-202-11	JC-100-05	JC-505-11
450 mm	JC-500-12	JC-202-21	JC-100-05	JC-505-12

Dissektions- und Fasszange, grob gerieft
Dissection and grasping forceps, heavy pattern

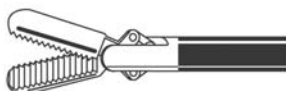

Arbeitslänge Working Length	Instr. Einsatz Jaw Insert	Schaft Tube shaft	Griff Handle	Komplett complete
220 mm	JC-500-13	JC-202-01	JC-100-05	JC-505-13
330 mm	JC-500-14	JC-202-11	JC-100-05	JC-505-14
450 mm	JC-500-15	JC-202-21	JC-100-05	JC-505-15

Maryland Fasszange
Maryland grasping forceps

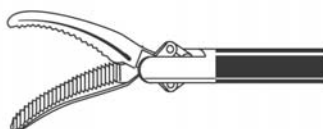

Arbeitslänge Working Length	Instr. Einsatz Jaw Insert	Schaft Tube shaft	Griff Handle	Komplett complete
220 mm	JC-500-16	JC-202-01	JC-100-05	JC-505-16
330 mm	JC-500-17	JC-202-11	JC-100-05	JC-505-17
450 mm	JC-500-18	JC-202-21	JC-100-05	JC-505-18

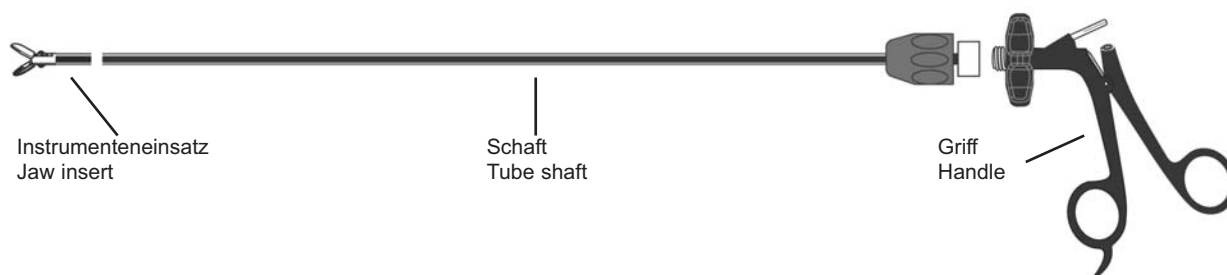
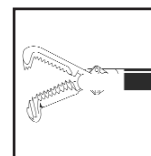

Kelly Fasszange
Kelly grasping forceps

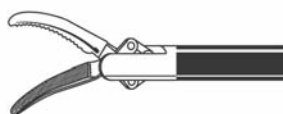

Arbeitslänge Working Length	Instr. Einsatz Jaw Insert	Schaft Tube shaft	Griff Handle	Komplett complete
220 mm	JC-500-19	JC-202-01	JC-100-05	JC-505-19
330 mm	JC-500-20	JC-202-11	JC-100-05	JC-505-20
450 mm	JC-500-21	JC-202-21	JC-100-05	JC-505-21

Lange atraumatische Fasszange
Long atraumatic grasping forceps

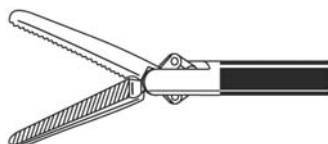

Arbeitslänge Working Length	Instr. Einsatz Jaw Insert	Schaft Tube shaft	Griff Handle	Komplett complete
220 mm	JC-500-22	JC-202-01	JC-100-05	JC-505-22
330 mm	JC-500-23	JC-202-11	JC-100-05	JC-505-23
450 mm	JC-500-24	JC-202-21	JC-100-05	JC-505-24

Lange atraumatische Fasszange, konkav
Long atraumatic concave grasping forceps

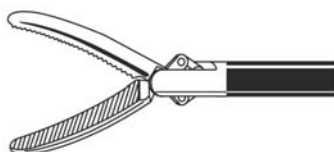

Arbeitslänge Working Length	Instr. Einsatz Jaw Insert	Schaft Tube shaft	Griff Handle	Komplett complete
220 mm	JC-500-25	JC-202-01	JC-100-05	JC-505-25
330 mm	JC-500-26	JC-202-11	JC-100-05	JC-505-26
450 mm	JC-500-27	JC-202-21	JC-100-05	JC-505-27

Fasszange gefenestert
Fenestrated grasping forceps

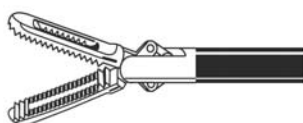

Arbeitslänge Working Length	Instr. Einsatz Jaw Insert	Schaft Tube shaft	Griff Handle	Komplett complete
220 mm	JC-500-28	JC-202-01	JC-100-05	JC-505-28
330 mm	JC-500-29	JC-202-11	JC-100-05	JC-505-29
450 mm	JC-500-30	JC-202-21	JC-100-05	JC-505-30

Mikro-Fasszange gefenestert
Micro-fenestrated grasping forceps

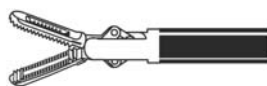

Arbeitslänge Working Length	Instr. Einsatz Jaw Insert	Schaft Tube shaft	Griff Handle	Komplett complete
220 mm	JC-500-31	JC-202-01	JC-100-05	JC-505-31
330 mm	JC-500-32	JC-202-11	JC-100-05	JC-505-32
450 mm	JC-500-33	JC-202-21	JC-100-05	JC-505-33

Mikro-Fasszange
Micro-grasping forceps

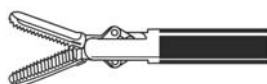

Arbeitslänge Working Length	Instr. Einsatz Jaw Insert	Schaft Tube shaft	Griff Handle	Komplett complete
220 mm	JC-500-34	JC-202-01	JC-100-05	JC-505-34
330 mm	JC-500-35	JC-202-11	JC-100-05	JC-505-35
450 mm	JC-500-36	JC-202-21	JC-100-05	JC-505-36

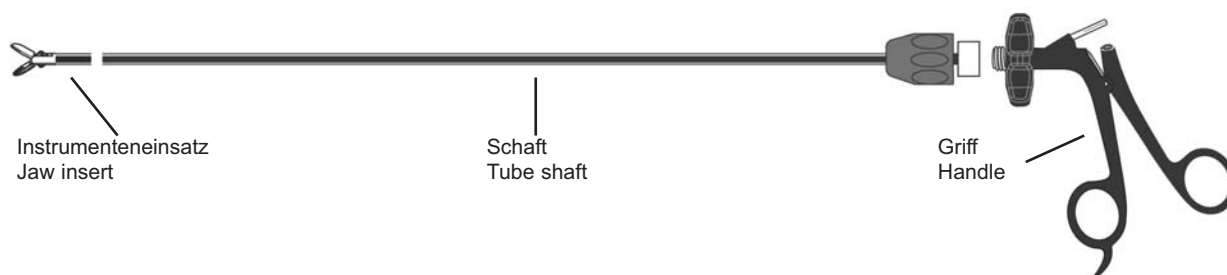
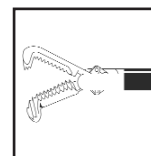

Mikro-Maryland Fasszange
Micro-Maryland grasping forceps

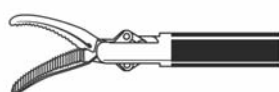

Arbeitslänge Working Length	Instr. Einsatz Jaw Insert	Schaft Tube shaft	Griff Handle	Komplett complete
220 mm	JC-500-37	JC-202-01	JC-100-05	JC-505-37
330 mm	JC-500-38	JC-202-11	JC-100-05	JC-505-38
450 mm	JC-500-39	JC-202-21	JC-100-05	JC-505-39

Lange atraumatische Fasszange
Long atraumatic grasping forceps

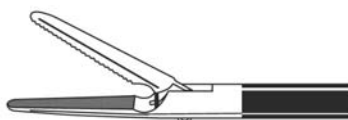

Arbeitslänge Working Length	Instr. Einsatz Jaw Insert	Schaft Tube shaft	Griff Handle	Komplett complete
220 mm	JC-500-40	JC-202-01	JC-100-05	JC-505-40
330 mm	JC-500-41	JC-202-11	JC-100-05	JC-505-41
450 mm	JC-500-42	JC-202-21	JC-100-05	JC-505-42

Fasszange, gerade
Grasping forceps, straight



Arbeitslänge Working Length	Instr. Einsatz Jaw Insert	Schaft Tube shaft	Griff Handle	Komplett complete
220 mm	JC-500-43	JC-202-01	JC-100-05	JC-505-43
330 mm	JC-500-44	JC-202-11	JC-100-05	JC-505-44
450 mm	JC-500-45	JC-202-21	JC-100-05	JC-505-45

Fasszange, gebogen
Grasping forceps, curved

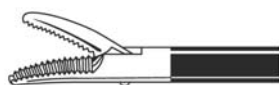

Arbeitslänge Working Length	Instr. Einsatz Jaw Insert	Schaft Tube shaft	Griff Handle	Komplett complete
220 mm	JC-500-46	JC-202-01	JC-100-05	JC-505-46
330 mm	JC-500-47	JC-202-11	JC-100-05	JC-505-47
450 mm	JC-500-48	JC-202-21	JC-100-05	JC-505-48

Alligator-Fasszange
Alligator grasping forceps



Arbeitslänge Working Length	Instr. Einsatz Jaw Insert	Schaft Tube shaft	Griff Handle	Komplett complete
220 mm	JC-500-49	JC-202-01	JC-100-05	JC-505-49
330 mm	JC-500-50	JC-202-11	JC-100-05	JC-505-50
450 mm	JC-500-51	JC-202-21	JC-100-05	JC-505-51

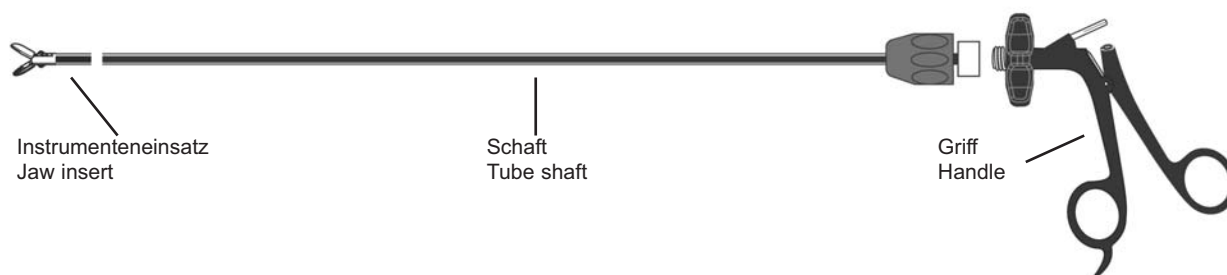
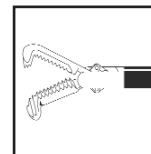

Mixer Fasszange 60°
Mixer grasping forceps 60°

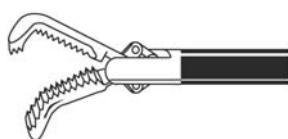

Arbeitslänge Working Length	Instr. Einsatz Jaw Insert	Schaft Tube shaft	Griff Handle	Komplett complete
220 mm	JC-500-52	JC-202-01	JC-100-05	JC-505-52
330 mm	JC-500-53	JC-202-11	JC-100-05	JC-505-53
450 mm	JC-500-54	JC-202-21	JC-100-05	JC-505-54

Mixer Fasszange 90°
Mixer grasping forceps 90°

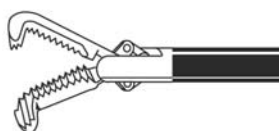

Arbeitslänge Working Length	Instr. Einsatz Jaw Insert	Schaft Tube shaft	Griff Handle	Komplett complete
220 mm	JC-500-55	JC-202-01	JC-100-05	JC-505-55
330 mm	JC-500-56	JC-202-11	JC-100-05	JC-505-56
450 mm	JC-500-57	JC-202-21	JC-100-05	JC-505-57

Alligator Fasszange, mit Löffel
Alligator grasping forceps, with spoon

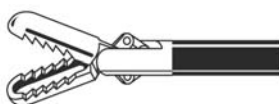

Arbeitslänge Working Length	Instr. Einsatz Jaw Insert	Schaft Tube shaft	Griff Handle	Komplett complete
220 mm	JC-500-58	JC-202-01	JC-100-05	JC-505-58
330 mm	JC-500-59	JC-202-11	JC-100-05	JC-505-59
450 mm	JC-500-60	JC-202-21	JC-100-05	JC-505-60

Da Vinci Krallengreifer
Da Vinci aggressive grasping forceps

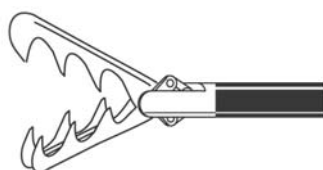

Arbeitslänge Working Length	Instr. Einsatz Jaw Insert	Schaft Tube shaft	Griff Handle	Komplett complete
220 mm	JC-500-61	JC-202-01	JC-100-05	JC-505-61
330 mm	JC-500-62	JC-202-11	JC-100-05	JC-505-62
450 mm	JC-500-63	JC-202-21	JC-100-05	JC-505-63

Maxi atraumatische Fasszange
Maxi atraumatic grasping forceps

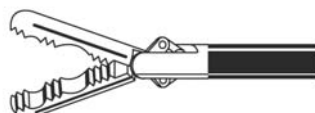

Arbeitslänge Working Length	Instr. Einsatz Jaw Insert	Schaft Tube shaft	Griff Handle	Komplett complete
220 mm	JC-500-64	JC-202-01	JC-100-05	JC-505-64
330 mm	JC-500-65	JC-202-11	JC-100-05	JC-505-65
450 mm	JC-500-66	JC-202-21	JC-100-05	JC-505-66

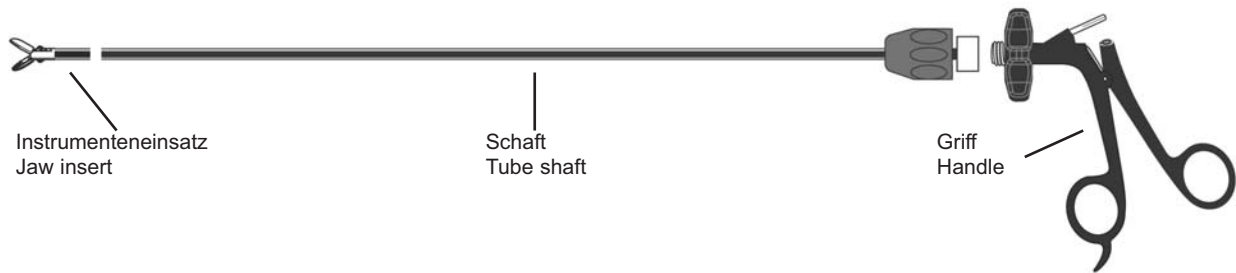
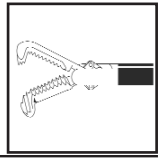

Mc Kearnan Fasszange, gefenstert
Mc Kearnan grasping forceps, fenestrated

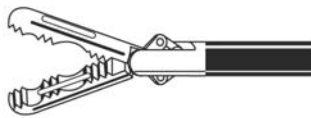

Arbeitslänge Working Length	Instr. Einsatz Jaw Insert	Schaft Tube shaft	Griff Handle	Komplett complete
220 mm	JC-500-67	JC-202-01	JC-100-05	JC-505-67
330 mm	JC-500-68	JC-202-11	JC-100-05	JC-505-68
450 mm	JC-500-69	JC-202-21	JC-100-05	JC-505-69

Fasszange, stumpf
Oviduct grasping forceps

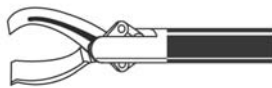

Arbeitslänge Working Length	Instr. Einsatz Jaw Insert	Schaft Tube shaft	Griff Handle	Komplett complete
220 mm	JC-500-70	JC-202-01	JC-100-05	JC-505-70
330 mm	JC-500-71	JC-202-11	JC-100-05	JC-505-71
450 mm	JC-50072	JC-202-21	JC-100-05	JC-505-72

Dissektions- und Fasszange fein gerieft
Dissecting and grasping forceps, fine pattern

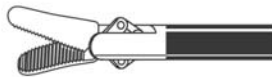

Arbeitslänge Working Length	Instr. Einsatz Jaw Insert	Schaft Tube shaft	Griff Handle	Komplett complete
220 mm	JC-500-73	JC-202-01	JC-100-05	JC-505-73
330 mm	JC-500-74	JC-202-11	JC-100-05	JC-505-74
450 mm	JC-500-75	JC-202-21	JC-100-05	JC-505-75

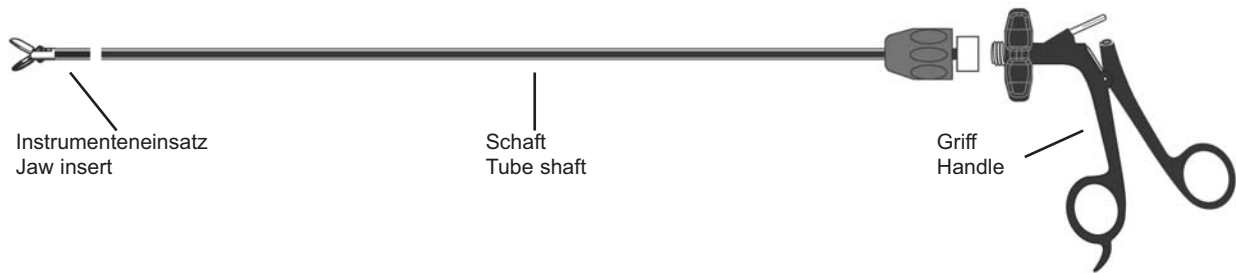
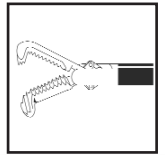

**“Multiple teeth” Fasszange
Multiple teeth grasping forceps**

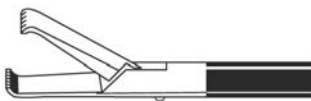

Arbeitslänge Working Length	Instr. Einsatz Jaw Insert	Schaft Tube shaft	Griff Handle	Komplett complete
220 mm	JC-500-76	JC-202-01	JC-100-05	JC-505-76
330 mm	JC-500-77	JC-202-11	JC-100-05	JC-505-77
450 mm	JC-500-78	JC-202-21	JC-100-05	JC-505-78

**Fasszange mit Zähnen
Rat-Tooth grasping forceps**

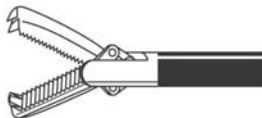

Arbeitslänge Working Length	Instr. Einsatz Jaw Insert	Schaft Tube shaft	Griff Handle	Komplett complete
220 mm	JC-500-79	JC-202-01	JC-100-05	JC-505-79
330 mm	JC-500-80	JC-202-11	JC-100-05	JC-505-80
450 mm	JC-500-81	JC-202-21	JC-100-05	JC-505-81

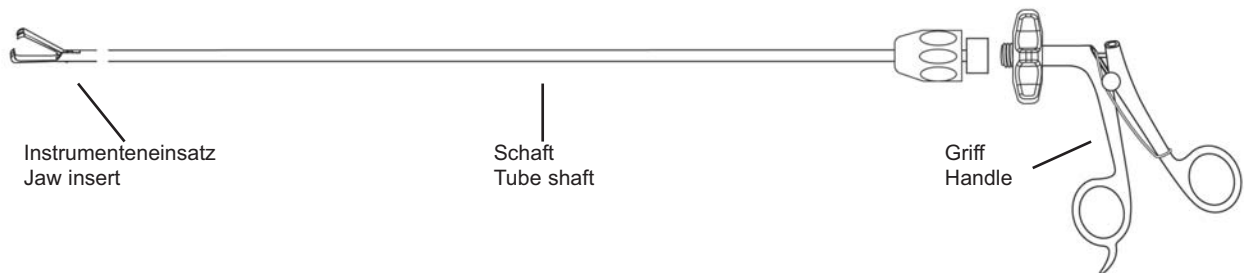

**Krallengreifer
Claw grasping forceps**

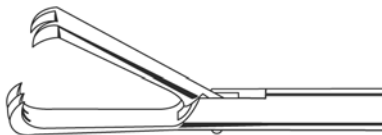

Arbeitslänge Working Length	Instr. Einsatz Jaw Insert	Schaft Tube shaft	Griff Handle	Komplett complete
220 mm	JC-500-82	JC-200-01	JC-100-02	JC-505-82
330 mm	JC-500-83	JC-200-11	JC-100-02	JC-505-83
450 mm	JC-500-84	JC-200-21	JC-100-02	JC-505-84

**Hakenzange, doppelbeweglich
Tenaculum forceps**

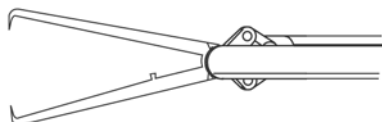

Arbeitslänge Working Length	Instr. Einsatz Jaw Insert	Schaft Tube shaft	Griff Handle	Komplett complete
220 mm	JC-500-85	JC-200-01	JC-100-02	JC-505-85
330 mm	JC-500-86	JC-200-11	JC-100-02	JC-505-86
450 mm	JC-500-87	JC-200-21	JC-100-02	JC-505-87

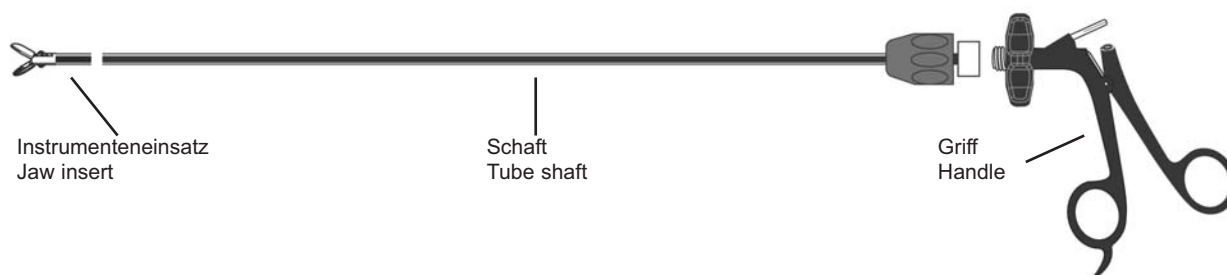
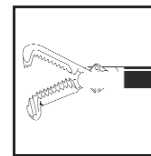

Biopsie-Zange, doppelbeweglich
Biopsy spoon forcipes, double action

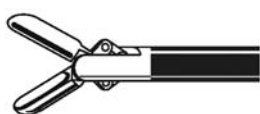

Arbeitslänge Working Length	Instr. Einsatz Jaw Insert	Schaft Tube shaft	Griff Handle	Komplett complete
220 mm	JC-501-01	JC-202-01	JC-100-05	JC-506-01
330 mm	JC-501-02	JC-202-11	JC-100-05	JC-506-02
450 mm	JC-501-03	JC-202-21	JC-100-05	JC-506-03

Biopsie-Zange mit 2 Dornen, doppelbeweglich
Biopsy spoon forceps with 2 teeth, double action

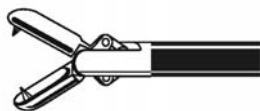

Arbeitslänge Working Length	Instr. Einsatz Jaw Insert	Schaft Tube shaft	Griff Handle	Komplett complete
220 mm	JC-501-04	JC-202-01	JC-100-05	JC-506-04
330 mm	JC-501-05	JC-202-11	JC-100-05	JC-506-05
450 mm	JC-501-06	JC-202-21	JC-100-05	JC-506-06

Biopsy-Zange, einzelbeweglich
Biopsy spoon forceps, single action



Arbeitslänge Working Length	Instr. Einsatz Jaw Insert	Schaft Tube shaft	Griff Handle	Komplett complete
220 mm	JC-501-07	JC-202-01	JC-100-05	JC-506-07
330 mm	JC-501-08	JC-202-11	JC-100-05	JC-506-08
450 mm	JC-501-09	JC-202-21	JC-100-05	JC-506-09

Biopsie-Zange mit 2 Dornen, einzelbeweglich
Biopsy spoon forceps with 2 teeth, single action

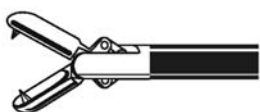

Arbeitslänge Working Length	Instr. Einsatz Jaw Insert	Schaft Tube shaft	Griff Handle	Komplett complete
220 mm	JC-501-10	JC-202-01	JC-100-05	JC-506-10
330 mm	JC-501-11	JC-202-11	JC-100-05	JC-506-11
450 mm	JC-501-12	JC-202-21	JC-100-05	JC-506-12

Blaksley Biopsy-Zange
Blakesley biopsy forceps



Arbeitslänge Working Length	Instr. Einsatz Jaw Insert	Schaft Tube shaft	Griff Handle	Komplett complete
220 mm	JC-501-13	JC-202-01	JC-100-05	JC-506-13
330 mm	JC-501-14	JC-202-11	JC-100-05	JC-506-14
450 mm	JC-501-15	JC-202-21	JC-100-05	JC-506-15

Biopsy-Stanze
Biopsy Punch

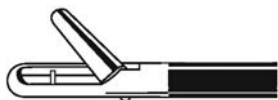

Arbeitslänge Working Length	Instr. Einsatz Jaw Insert	Schaft Tube shaft	Griff Handle	Komplett complete
220 mm	JC-501-16	JC-202-01	JC-100-05	JC-506-16
330 mm	JC-501-17	JC-202-11	JC-100-05	JC-506-17
450 mm	JC-501-18	JC-202-21	JC-100-05	JC-506-18

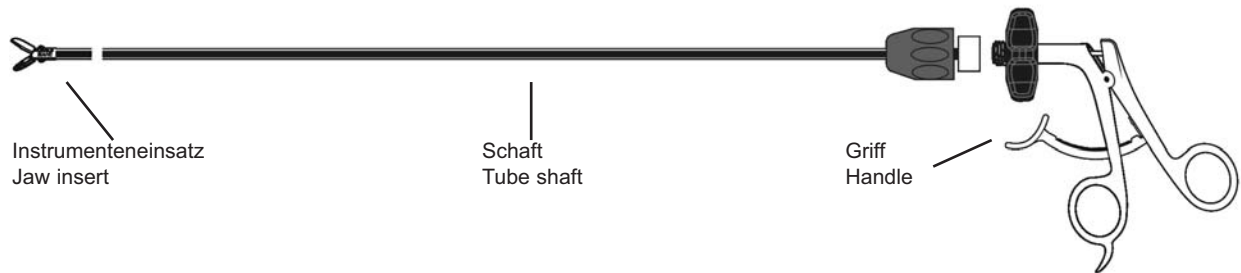
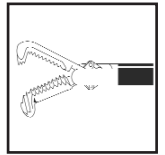

Krokodil-Fasszange
Crocodile grasping forceps

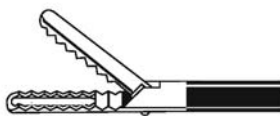

Arbeitslänge Working Length	Instr. Einsatz Jaw Insert	Schaft Tube shaft	Griff Handle	Komplett complete
220 mm	JC-502-01	JC-202-01	JC-100-03	JC-507-01
330 mm	JC-502-02	JC-202-11	JC-100-03	JC-507-02
450 mm	JC-502-03	JC-202-21	JC-100-03	JC-507-03

“Retraction”-Fasszange
Retraction grasping Forceps

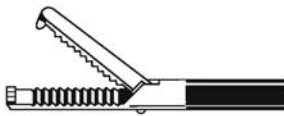

Arbeitslänge Working Length	Instr. Einsatz Jaw Insert	Schaft Tube shaft	Griff Handle	Komplett complete
220 mm	JC-502-04	JC-202-01	JC-100-03	JC-507-04
330 mm	JC-502-05	JC-202-11	JC-100-03	JC-507-05
450 mm	JC-502-06	JC-202-21	JC-100-03	JC-507-06

Darm-Fasszange, gefenestert
Bowel grasping forceps, fenestrated

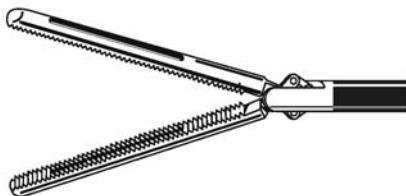

Arbeitslänge Working Length	Instr. Einsatz Jaw Insert	Schaft Tube shaft	Griff Handle	Komplett complete
220 mm	JC-502-07	JC-202-01	JC-100-03	JC-507-07
330 mm	JC-502-08	JC-202-11	JC-100-03	JC-507-08
450 mm	JC-502-09	JC-202-21	JC-100-03	JC-507-09

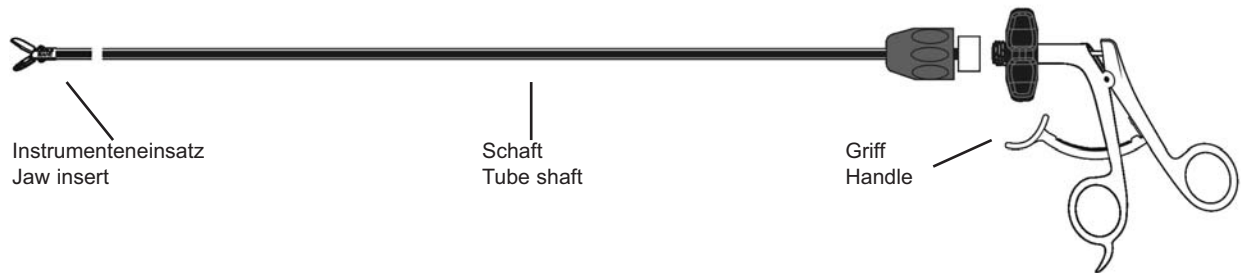
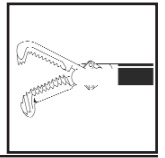

Allis Fasszange
Allis grasping forceps

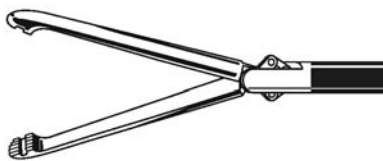

Arbeitslänge Working Length	Instr. Einsatz Jaw Insert	Schaft Tube shaft	Griff Handle	Komplett complete
220 mm	JC-502-10	JC-202-01	JC-100-03	JC-507-10
330 mm	JC-502-11	JC-202-11	JC-100-03	JC-507-11
450 mm	JC-502-12	JC-202-21	JC-100-03	JC-507-12

De Bakey atraumatische Fasszange
De Bakey Atraumatic grasping forceps

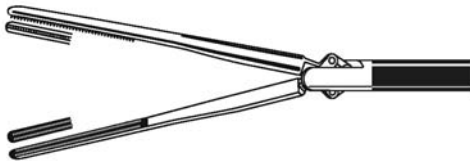

Arbeitslänge Working Length	Instr. Einsatz Jaw Insert	Schaft Tube shaft	Griff Handle	Komplett complete
220 mm	JC-502-13	JC-202-01	JC-100-03	JC-507-13
330 mm	JC-502-14	JC-202-11	JC-100-03	JC-507-14
450 mm	JC-502-15	JC-202-21	JC-100-03	JC-507-15

Babcock Fasszange
Babcock grasping forceps

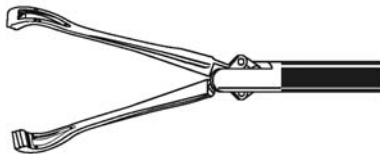

Arbeitslänge Working Length	Instr. Einsatz Jaw Insert	Schaft Tube shaft	Griff Handle	Komplett complete
220 mm	JC-502-16	JC-202-01	JC-100-03	JC-507-16
330 mm	JC-502-17	JC-202-11	JC-100-03	JC-507-17
450 mm	JC-502-18	JC-202-21	JC-100-03	JC-507-18

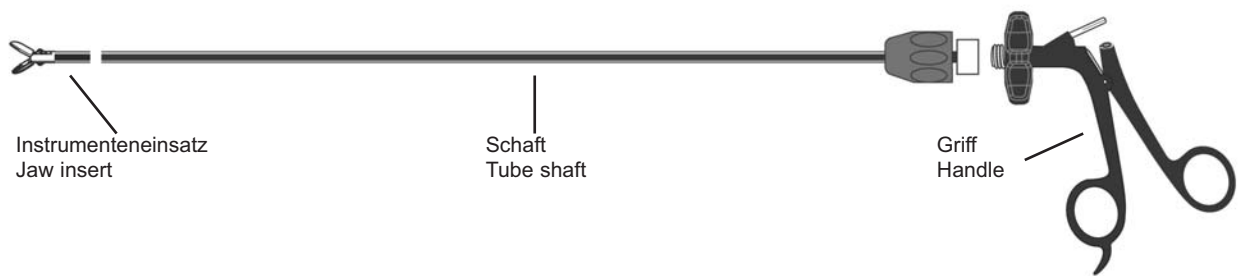
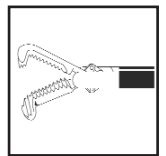

Maryland Fasszange
Maryland grasping forceps

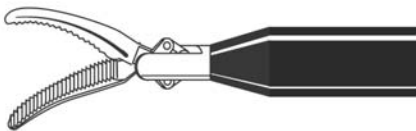

Arbeitslänge Working Length	Instr. Einsatz Jaw Insert	Schaft Tube shaft	Griff Handle	Komplett complete
220 mm	JC-010-01	JC-202-02	JC-100-05	JC-015-01
330 mm	JC-010-02	JC-202-12	JC-100-05	JC-015-02
450 mm	JC-010-03	JC-202-22	JC-100-05	JC-015-03

Fasszange mit Zähnen
Rat-Tooth grasping forceps

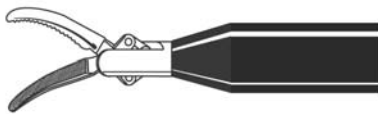

Arbeitslänge Working Length	Instr. Einsatz Jaw Insert	Schaft Tube shaft	Griff Handle	Komplett complete
220 mm	JC-010-04	JC-202-02	JC-100-05	JC-015-04
330 mm	JC-010-05	JC-202-12	JC-100-05	JC-015-05
450 mm	JC-010-06	JC-202-22	JC-100-05	JC-015-06

Krallengreifer
Claw grasping forceps



Arbeitslänge Working Length	Instr. Einsatz Jaw Insert	Schaft Tube shaft	Griff Handle	Komplett complete
220 mm	JC-010-07	JC-202-02	JC-100-05	JC-015-07
330 mm	JC-010-08	JC-202-12	JC-100-05	JC-015-08
450 mm	JC-010-09	JC-202-22	JC-100-05	JC-015-09

Hakenzange, doppelbeweglich
Tenaculum forcipes, double action

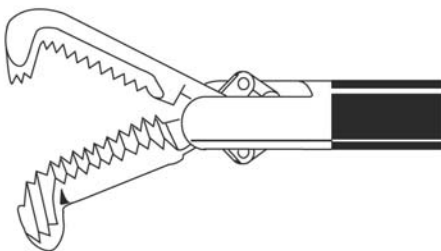

Arbeitslänge Working Length	Instr. Einsatz Jaw Insert	Schaft Tube shaft	Griff Handle	Komplett complete
220 mm	JC-010-10	JC-202-02	JC-100-05	JC-015-10
330 mm	JC-010-11	JC-202-12	JC-100-05	JC-015-11
450 mm	JC-010-12	JC-202-22	JC-100-05	JC-015-12

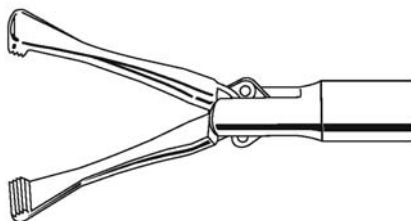
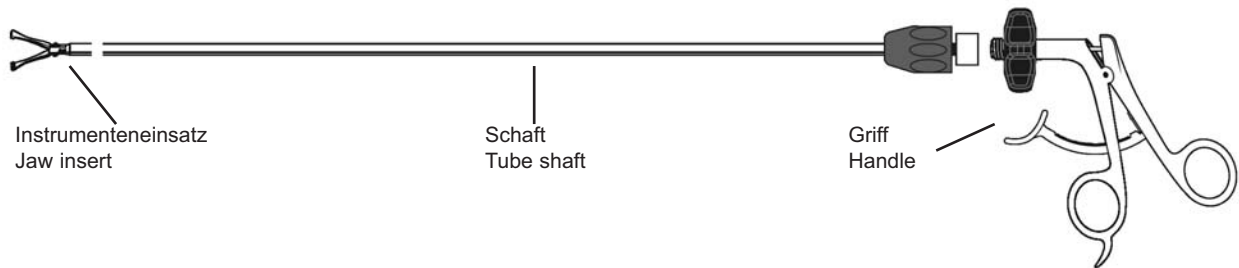
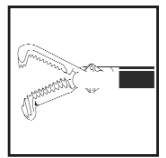

Allis Fasszange
Allis grasping forceps

Arbeitslänge Working Length	Instr. Einsatz Jaw Insert	Schaft Tube shaft	Griff Handle	Komplett complete
220 mm	JC-010-13	JC-200-03	JC-100-03	JC-015-13
330 mm	JC-010-14	JC-200-13	JC-100-03	JC-015-14
450 mm	JC-010-15	JC-200-23	JC-100-03	JC-015-15

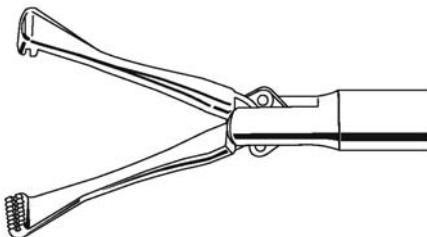

Allis atraumatische Fasszange
Allis atraumatic grasping forceps

Arbeitslänge Working Length	Instr. Einsatz Jaw Insert	Schaft Tube shaft	Griff Handle	Komplett complete
220 mm	JC-010-16	JC-200-03	JC-100-03	JC-015-16
330 mm	JC-010-17	JC-200-13	JC-100-03	JC-015-17
450 mm	JC-010-18	JC-200-23	JC-100-03	JC-015-18

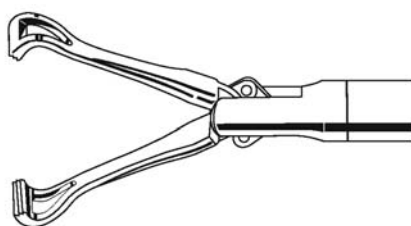

Babcock Fasszange
Babcock grasping forceps

Arbeitslänge Working Length	Instr. Einsatz Jaw Insert	Schaft Tube shaft	Griff Handle	Komplett complete
220 mm	JC-010-19	JC-200-03	JC-100-03	JC-015-19
330 mm	JC-010-20	JC-200-13	JC-100-03	JC-015-20
450 mm	JC-010-21	JC-200-23	JC-100-03	JC-015-21

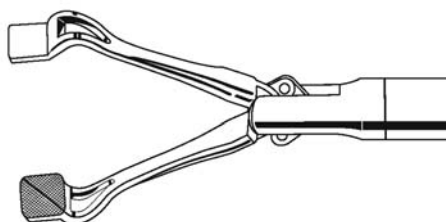

Babcock Fasszange, schaufelförmig
"Paddle" Babcock grasping forceps

Arbeitslänge Working Length	Instr. Einsatz Jaw Insert	Schaft Tube shaft	Griff Handle	Komplett complete
220 mm	JC-010-22	JC-200-03	JC-100-03	JC-015-22
330 mm	JC-010-23	JC-200-13	JC-100-03	JC-015-23
450 mm	JC-010-24	JC-200-23	JC-100-03	JC-015-24

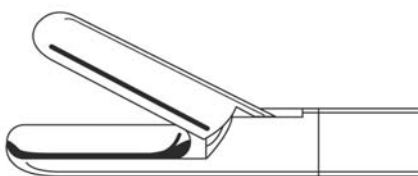
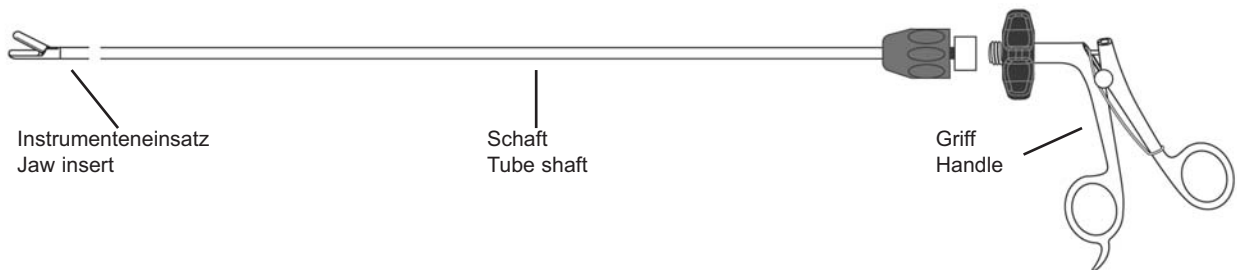
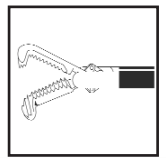

Löffelzange
Spoon grasping Forceps

Arbeitslänge Working Length	Instr. Einsatz Jaw Insert	Schaft Tube shaft	Griff Handle	Komplett complete
220 mm	JC-010-25	JC-200-03	JC-100-02	JC-015-25
330 mm	JC-010-26	JC-200-13	JC-100-02	JC-015-26
450 mm	JC-010-27	JC-200-23	JC-100-02	JC-015-27

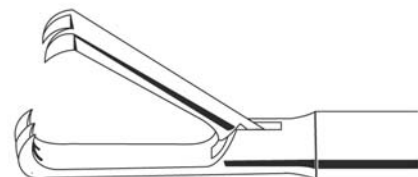

Krallengreifer, einzelbeweglich
Claw grasping forceps, single action

Arbeitslänge Working Length	Instr. Einsatz Jaw Insert	Schaft Tube shaft	Griff Handle	Komplett complete
220 mm	JC-010-28	JC-200-03	JC-100-02	JC-015-28
330 mm	JC-010-29	JC-200-13	JC-100-02	JC-015-29
450 mm	JC-010-30	JC-200-23	JC-100-02	JC-015-30

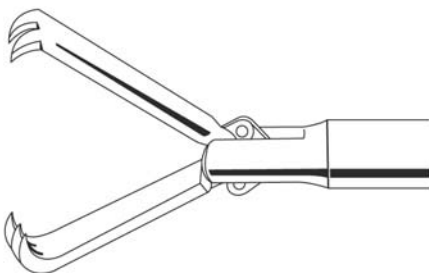

Krallengreifer, doppelbeweglich
Claw grasping forceps, double action

Arbeitslänge Working Length	Instr. Einsatz Jaw Insert	Schaft Tube shaft	Griff Handle	Komplett complete
220 mm	JC-010-31	JC-200-03	JC-100-02	JC-015-31
330 mm	JC-010-32	JC-200-13	JC-100-02	JC-015-32
450 mm	JC-010-33	JC-200-23	JC-100-02	JC-015-33

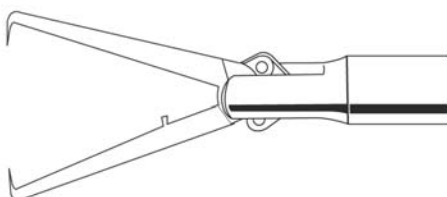

Hakenzange, doppelbeweglich
Tenaculum forceps, double action

Arbeitslänge Working Length	Instr. Einsatz Jaw Insert	Schaft Tube shaft	Griff Handle	Komplett complete
220 mm	JC-010-34	JC-200-03	JC-100-02	JC-015-34
330 mm	JC-010-35	JC-200-13	JC-100-02	JC-015-35
450 mm	JC-010-36	JC-200-23	JC-100-02	JC-015-36

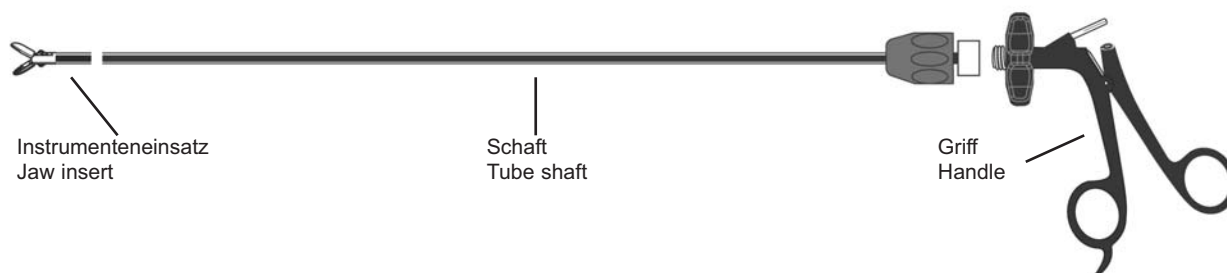
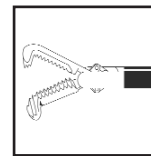

Peritoneal-Schere, gezahnt
Peritoneal scissors, serrated



Arbeitslänge Working Length	Instr. Einsatz Jaw Insert	Schaft Tube shaft	Griff Handle	Komplett complete
220 mm	JC-503-01	JC-202-01	JC-100-05	JC-508-01
330 mm	JC-503-02	JC-202-11	JC-100-05	JC-508-02
450 mm	JC-503-03	JC-202-21	JC-100-05	JC-508-03

Haken-Schere
Hook scissors



Arbeitslänge Working Length	Instr. Einsatz Jaw Insert	Schaft Tube shaft	Griff Handle	Komplett complete
220 mm	JC-503-04	JC-202-01	JC-100-05	JC-508-04
330 mm	JC-503-05	JC-202-11	JC-100-05	JC-508-05
450 mm	JC-503-06	JC-202-21	JC-100-05	JC-508-06

Baby-Metzenbaum-Schere, gebogen
Baby-Metzenbaum scissors, curved

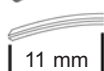
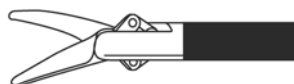

Arbeitslänge Working Length	Instr. Einsatz Jaw Insert	Schaft Tube shaft	Griff Handle	Komplett complete
220 mm	JC-503-07	JC-202-01	JC-100-05	JC-508-07
330 mm	JC-503-08	JC-202-11	JC-100-05	JC-508-08
450 mm	JC-503-09	JC-202-21	JC-100-05	JC-508-09

Metzenbaum-Schere, gebogen
Metzenbaum scissors, curved

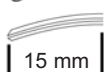
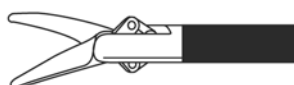

Arbeitslänge Working Length	Instr. Einsatz Jaw Insert	Schaft Tube shaft	Griff Handle	Komplett complete
220 mm	JC-503-10	JC-202-01	JC-100-05	JC-508-10
330 mm	JC-503-11	JC-202-11	JC-100-05	JC-508-11
450 mm	JC-503-12	JC-202-21	JC-100-05	JC-508-12

Endo-Schere, gebogen
Endo scissors, curved

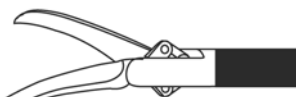

Arbeitslänge Working Length	Instr. Einsatz Jaw Insert	Schaft Tube shaft	Griff Handle	Komplett complete
220 mm	JC-503-13	JC-202-01	JC-100-05	JC-508-13
330 mm	JC-503-14	JC-202-11	JC-100-05	JC-508-14
450 mm	JC-503-15	JC-202-21	JC-100-05	JC-508-15

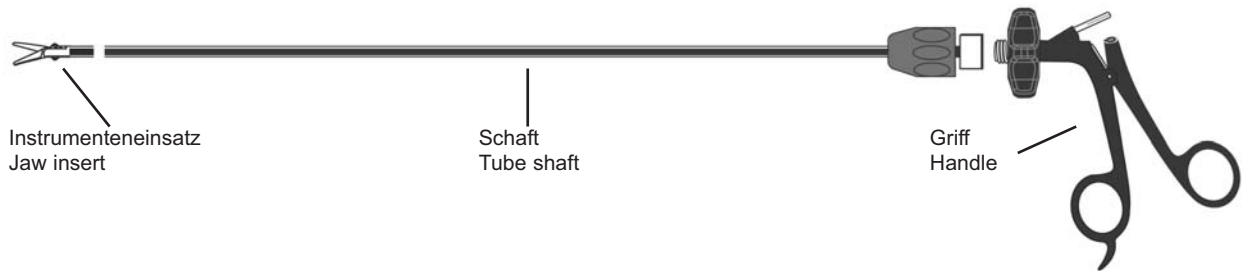
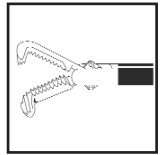

Metzenbaum-Schere, gerade, schwere Schneidenblätter-Ausführung
Metzenbaum scissors, straight, heavy blades pattern

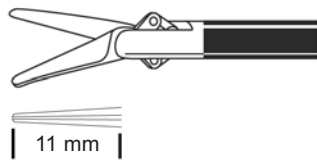

Arbeitslänge Working Length	Instr. Einsatz Jaw Insert	Schaft Tube shaft	Griff Handle	Komplett complete
220 mm	JC-503-16	JC-202-01	JC-100-05	JC-508-16
330 mm	JC-503-17	JC-202-11	JC-100-05	JC-508-17
450 mm	JC-503-18	JC-202-21	JC-100-05	JC-508-18

Metzenbaum-Schere, gebogen, schwere Schneidenblätter-Ausführung
Metzenbaum scissors, curved, heavy blades pattern

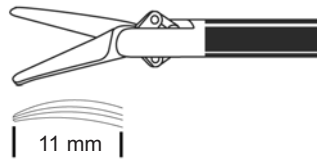

Arbeitslänge Working Length	Instr. Einsatz Jaw Insert	Schaft Tube shaft	Griff Handle	Komplett complete
220 mm	JC-503-19	JC-202-01	JC-100-05	JC-508-19
330 mm	JC-503-20	JC-202-11	JC-100-05	JC-508-20
450 mm	JC-503-21	JC-202-21	JC-100-05	JC-508-21

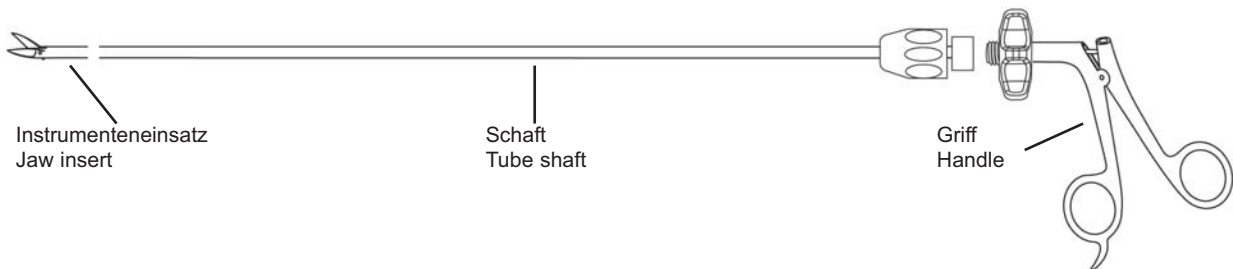

Mikro-Schere, gerade
Micro scissors, straight



Arbeitslänge Working Length	Instr. Einsatz Jaw Insert	Schaft Tube shaft	Griff Handle	Komplett complete
220 mm	JC-020-11	JC-200-01	JC-100-01	JC-020-01
330 mm	JC-020-12	JC-200-11	JC-100-01	JC-020-02
450 mm	JC-020-13	JC-200-21	JC-100-01	JC-020-03

Mikro-Schere, gebogen
Micro scissors, curved



Arbeitslänge Working Length	Instr. Einsatz Jaw Insert	Schaft Tube shaft	Griff Handle	Komplett complete
220 mm	JC-020-14	JC-200-01	JC-100-01	JC-020-04
330 mm	JC-020-15	JC-200-11	JC-100-01	JC-020-05
450 mm	JC-020-16	JC-200-21	JC-100-01	JC-020-06

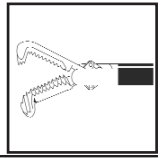

**Metallgriff mit Feder und Spülanschluss,
nicht drehbar**
**Metal Handle with Spring and Cleaning Port,
not rotatable**

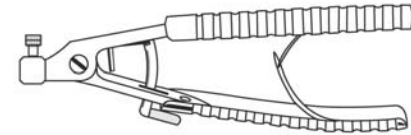

**Axialgriff mit Sperre und Spülanschluss,
nicht drehbar**
**Axial Handle with ratchet and Cleaning Port,
not rotatable**



Hartmetall, 3 mm
Tungsten Carbide, 3 mm

Arbeitslänge
Working Length

220 mm	JC-120-01
330 mm	JC-120-02
450 mm	JC-120-03

Hartmetall, 3 mm
Tungsten Carbide, 3 mm

Arbeitslänge
Working Length

220 mm	JC-220-01
330 mm	JC-220-02
450 mm	JC-220-03

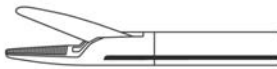

Gerieftes Maul, 3 mm
Serrated Jaw, 3 mm

220 mm	JC-121-01
330 mm	JC-121-02
450 mm	JC-121-03

Gerieftes Maul, 3 mm
Serrated Jaw, 3 mm

220 mm	JC-221-01
330 mm	JC-221-02
450 mm	JC-221-03

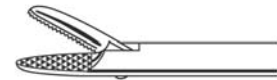

Hartmetall, 5 mm
Tungsten Carbide, 5 mm

220 mm	JC-122-01
330 mm	JC-122-02
450 mm	JC-122-03

Hartmetall, 5 mm
Tungsten Carbide, 5 mm

220 mm	JC-222-01
330 mm	JC-222-02
450 mm	JC-222-03



Gerieftes Maul, 5 mm
Serrated Jaw, 5 mm

220 mm	JC-123-01
330 mm	JC-123-02
450 mm	JC-123-03

Gerieftes Maul, 5 mm
Serrated Jaw, 5 mm

220 mm	JC-223-01
330 mm	JC-223-02
450 mm	JC-223-03

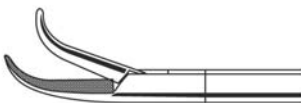

"Flamingo", 5 mm
"Flamingo", 5 mm

220 mm	JC-124-01
330 mm	JC-124-02
450 mm	JC-124-03

"Flamingo", 5 mm
"Flamingo", 5 mm

220 mm	JC-224-01
330 mm	JC-224-02
450 mm	JC-224-03

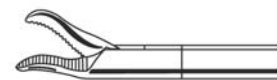

"Papagei", 5 mm
"Parrot", 5 mm

220 mm	JC-125-01
330 mm	JC-125-02
450 mm	JC-125-03

"Papagei", 5 mm
"Parrot", 5 mm

220 mm	JC-225-01
330 mm	JC-225-02
450 mm	JC-225-03

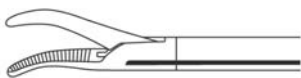

Hartmetall, links gebogen, 5 mm
Tungsten Carbide, curved left, 5 mm

220 mm	JC-126-01
330 mm	JC-126-02
450 mm	JC-126-03

Hartmetall, links gebogen, 5 mm
Tungsten Carbide, curved left, 5 mm

220 mm	JC-226-01
330 mm	JC-226-02
450 mm	JC-226-03

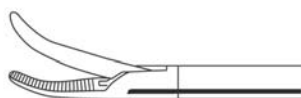

Hartmetall, rechts gebogen, 5 mm
Tungsten Carbide, curved right, 5 mm

220 mm	JC-127-01
330 mm	JC-127-02
450 mm	JC-127-03

Hartmetall, rechts gebogen, 5 mm
Tungsten Carbide, curved right, 5 mm

220 mm	JC-227-01
330 mm	JC-227-02
450 mm	JC-227-03

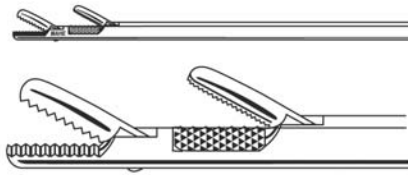
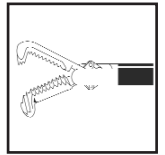

Easyknot
Für die einfache intrakorporale
Naht- und Knotentechnik
For easy intracorporeal
suturing and knot making

JC-195-01

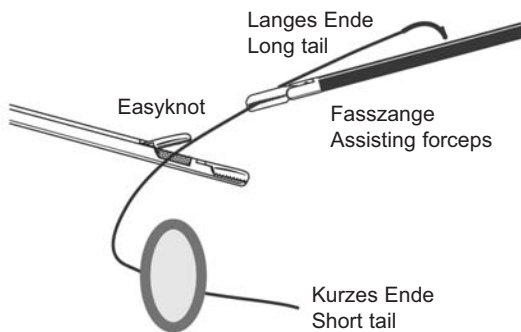
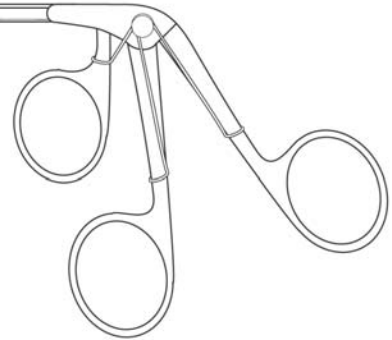

1. Einstich der Nadel mit Standard-Nadelhalter vornehmen und anschliessend ca. 1" - 2" Nahtmaterial auf Einstichseite der Nadel stehen lassen. Um Nahtmaterial zu fixieren, dieses mit einer Fasszange im Abstand von ca. 3" - 5" vom Operationspunkt fassen. Greifen Sie das Nahtmaterial mit dem oberen EASYKNOT-Maulteil in ca. 1-5" Entfernung von der Fasszange.

1. Take the stitch with a standard needle holder leaving 1" - 2" short tail on the needle entry side. Grasp the needle end of the suture with an assisting forceps about 3" - 5" from the operative site to fix the suture. Trap the suture under the upper jaw of the Easyknot device about 1-5" from the point of suture fixation.

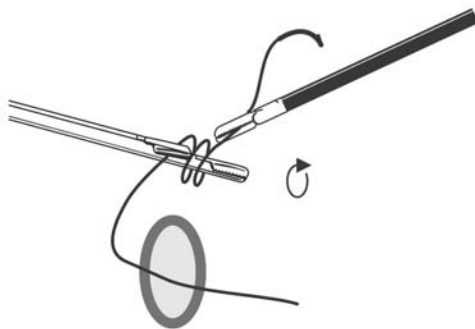

2. Benutzen Sie die Fasszange um das Nahtmaterial 2x um den EASYKNOT zu wickeln, d. h. unterhalb dem oberen EASYKNOT-Maulteils (vorzugsweise unterhalb des EASYKNOT herum)

2. Use the assisting forceps to wrap the suture around the Easyknot device twice, distal to the upper jaw (preferably going first under the device than over it)

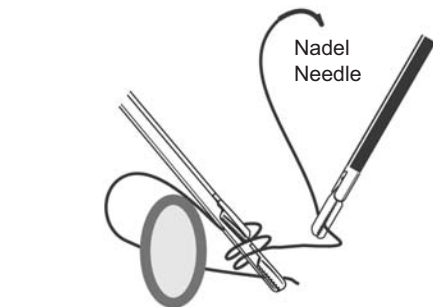

3. Bringen Sie beide Instrumente näher zum kurzen Ende des Nahtmaterials und greifen Sie dieses mit dem unteren EASYKNOT-Maulteil. Damit Sie einen Knoten machen können, öffnen Sie nun das obere EASYKNOT-Maulteil um das Nahtmaterial freizugeben und ziehen Sie den EASYKNOT sowie die Fasszange in entgegengesetzte Richtungen (ungefähr in die Ausgangsposition) zurück. Nun so fest anziehen wie benötigt.

3. Bring both instruments closer to the short tail and hold the tail with the lower jaw of the Easyknot device. Open the upper jaw to release trapped suture and pull the device (holding the suture tail) and assisting forceps (holding the needle end) in opposite direction (relative to initial positions) to establish a flat half hitch. Cinch and tighten as needed.

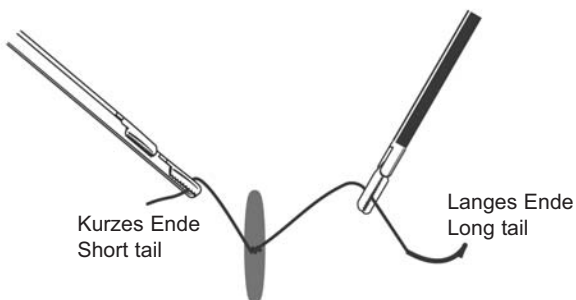

4. Wiederholen Sie die Schritte 1 bis 3 um einen "quadratischen" Knoten zu bilden

4. Repeat the procedure to form additional half hitches making sure to reverse the direction of pulling on the suture ends to establish a square knot. For instance, if the short end starts on the right side of the incision, it should end at the left side after the first half hitch and again on the right side after the second half hitch.

Entwickelt in Zusammenarbeit mit Dr. Carlos Rotman und Dr. Harrith Hasson, Chicago / USA
Developed in cooperation with Drs. Carlos Rotman and Harrith Hasson, Chicago / USA

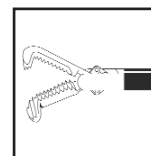

**Endo-Schlinge, Semm's Sicherheitsbinder mit Fadenführungsrohr; 12 St./Pckg.
Endo-Loop, Semm's safety loop with thread-guiding tube, 12 pcs./pack**



Faden/Thread		Art. Nr. / No.
USP 0 / 4 metric	Catgut plain	JC-190-01
USP 1 / 4 metric	Catgut plain	JC-190-02
USP 2 / 5 metric	Catgut plain	JC-190-03
USP 1 / 4 metric	Catgut plain	JC-190-04
USP 0 / 3,5 metric	Seralene versteift stiffed with Serafit	JC-190-05

**CISH-Endo-Schlinge, Semm's Sicherheitsbinder mit Fadenführungsrohr; 12 St./Pckg.
CISH-Endo-Loop, Semm's safety loop with thread-guiding tube, 12 pcs./pack**



Faden/Thread		Art. Nr. / No.
USP 0 / 4 metric	Catgut plain	JC-190-06
USP 1 / 4 metric	Seralene versteift stiffed with Serafit	JC-190-07

**Serag-Binder, mit Fadenführungsrohr; 12 St./Pckg.
Serag-loop, with thread-guiding tube, 12 pcs./pack**

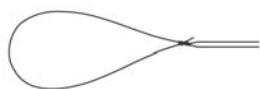

Faden/Thread		Art. Nr. / No.
USP 1 / 4 metric	Seralene Ligaturschlinge / ligature loop	JC-190-08

**Endo-Ligatur, mit Fadenführungsrohr, Fadenlänge 800 mm, 12 St./Pckg.
Endo-ligature, with thread-guiding tube, thread length 800 mm, 12 pcs./pack**



Faden/Thread		Art. Nr. / No.
USP 2 / 6 metric	Catgut plain	JC-190-09



**Endo-Naht, mit Fadenführungsrohr, Fadenlänge 800 mm, 12 St./Pckg.
Endo-ligature, with thread-guiding tube, thread length 800, 12 pcs./pack.**



Faden/Thread		Art. Nr. / No.	Nadel / Needle
USP 1 / 5 metric	Catgut plain	JC-191-01	JC-191-11
USP 2 / 6 metric	Catgut plain	JC-191-02	JC-191-12



USP 2 / 5 metric	Catgut plain	JC-191-03	JC-191-13
USP 1 / 6 metric	Catgut plain	JC-191-04	JC-191-14
USP 2 / 5 metric	Catgut plain	JC-191-05	JC-191-15



USP 1 / 4 metric	Seralene	JC-191-06	JC-191-16
USP 1 / 4 metric	Seralene	JC-191-07	JC-191-17



USP 0 / 3,5 metric	Seralene	JC-191-08	JC-191-18
USP 1 / 4 metric	Seralene	JC-191-09	JC-191-19



**Mikro-Naht, PDS II, violett, intracorporale Knotung, Fadenlänge 350 mm
Micro-suture, PDS II, violet, intracorporal knotting, thread length 350 mm**

Faden/Thread	Art. Nr. / No.
USP 4 / 1-5 metric	JC-190-10

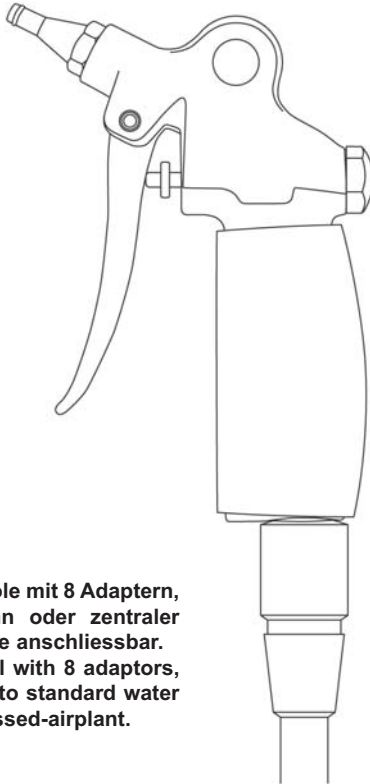
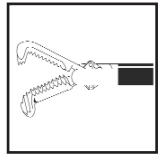

Reinigungspistole mit 8 Adaptern,
an Wasserhahn oder zentraler
Druckluftanlage anschliessbar.
Cleaning Pistol with 8 adaptors,
attachachable to standard water
tap or compressed-airplant.

JC-290-01

**Adaptor
Adaptors**



für Spritzen und Kanülen mit Recordkonus
for syringes and cannulas with record cone
JC-290-02



für Mess- und Blutpipetten
for measuring and blood pipettes
JC-290-03



für Katheter, Ventile etc.
for catheters, valves etc.
JC-290-04



für Drainageschläuche
for drainage tubing
JC-290-05



für Spritzen und Kanülen mit Luer-Konus
for syringes and cannulas with Luer-cone
JC-290-06



Brause für Flächen und Hohlräume
spray jet for surfaces and cavities
JC-290-07

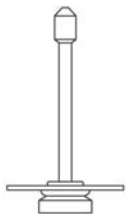

für Flaschen und
Erlenmeyerkolben
for bottles and Erlenmeyer flaks

JC-290-08

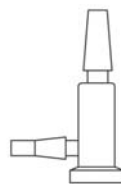

Wasserstrahlpumpe zum
Absaugen aus Winkel und
Hohlräumen
Water jet pump for suction out
of corner and cavities

JC-290-09



Wandhalter für Adapter
Wall Support for adaptors

JC-290-10

**Sonderzubehör
Special Accessories**

Entkalkungsadapter
Decalcifying Adaptor

JC-290-50

Rückflussverhinderer
Back-flow blocking
valve

JC-290-51

Tischrosette zum festen Einbau der Reinigungspistole in Spültische
Table-top rosette for installation of the cleaning pistol in the sink or a
countertop

JC-290-52

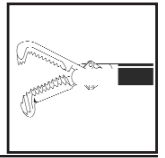

AUTOCLAVE
134° C / 273° F

OP-Laparoskop
Operating Laparoscope

JC-120-60

Arbeits- \varnothing
Working- \varnothing 10,0 mm

Länge
Length 280 mm

Instrumentenkanal \varnothing
Instrument channel 6 mm

Blickrichtung
Direction of view 0°



Lichtleitkabel Glasfaser
Light Guide Cable (glass fiber)

\varnothing	Nutzlänge working length	
3,5 mm	1800 mm	JB-395-18
3,5 mm	2300 mm	JB-395-23
5,0 mm	1800 mm	JB-590-18
5,0 mm	2300 mm	JB-590-23

Mit Silikon-Kautschuk Ummantelung, sterilisierbar, wasserdicht, sehr flexibel, temperaturbeständig von -60° C bis ca +180° Celsius

With silicone-rubber sheath, autoclavable, waterproof, very flexible, heat resistant from approx. -60 to approx. + 180° Centigrade



Ring-Applikator
Ring Applicator

JC-540-06	\varnothing 6 mm, AL 330 mm / Working length 6 mm, AL 330 mm
JC-540-07	\varnothing 7 mm, AL 290 mm / Working length 7 mm, AL 290 mm
JC-540-10	Konus für / Insert Cones for JC-540-06, JC-540-07
JC-540-11	Schieber für / Sliding bolt for JC-540-06, JC-540-07

Lichtquellen-Adapter
Light Source-Adapter

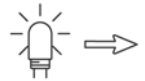

Olympus	JB-090-10	
Storz	JB-090-11	
ACMI / British Standard	JB-090-12	
Wolf / Dyonics	JB-090-13	

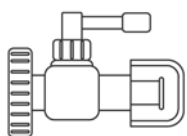

Ansatz für \varnothing 10 mm OP-Laparoskop mit 1 Hahn, inkl. Dichtung
Adapter for \varnothing 10 mm Operating Laparoscope incl. 1 stop cock and sealing cap

JC-540-90

Dichtungen für Ansatz
Sealing caps for stop cock

JC-540-91

Endoskop-Adapter
Endoscope-Adapter

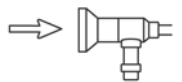

Wolf	JB-090-20	
ACMI / British Standard	JB-090-21	
Storz / Olympus	JB-090-22	
Stryker	JB-090-23	

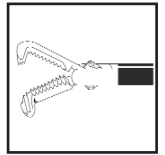

Laparoskop, ø 5 mm, AL 300 mm
Laparoscope, ø 5 mm, WL 300 mm
Blickrichtung
Direction of view
0° **JB-025-00**
30° **JB-025-30**



Laparoskop, ø 6,5 mm, AL 300 mm
Laparoscope, ø 6-5 mm, WL 300 mm
Blickrichtung
Direction of view
0° **JB-026-00**
30° **JB-026-30**

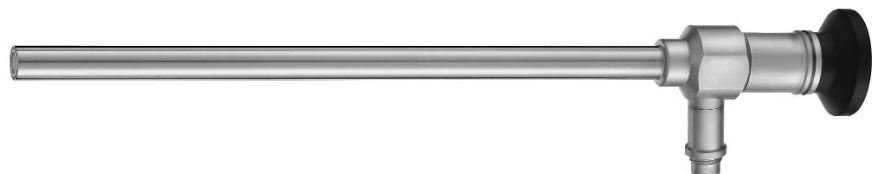

Laparoskop, ø 10 mm, AL 190 mm
Laparoscope, ø 10 mm, WL 190 mm
Blickrichtung
Direction of view
0° **JB-125-00**

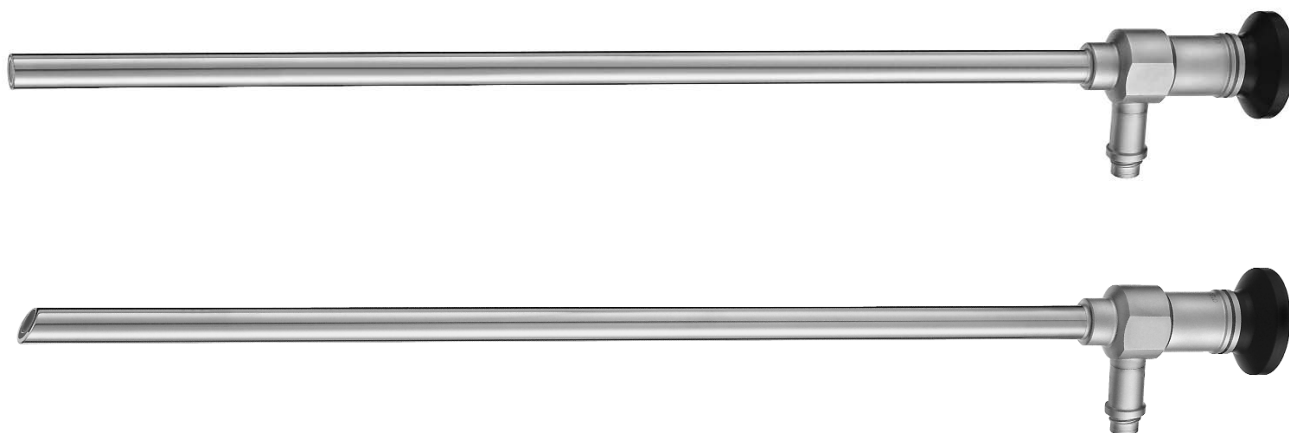
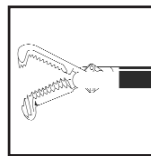

Laparoskop, ø 10 mm, AL 310 mm
Laparoscope, ø 10 mm, WL 310 mm
Blickrichtung
Direction of view
0° **JB-120-00**
30° **JB-120-30**
45° **JB-120-45**



CM Instrumente GmbH
Gänsäcker 56
78532 Tuttlingen
Germany

Tel. +49 7462 20420-70
Fax +49 7462 20420-62
info@cm-instrumente.de
www.cm-instrumente.de