



M2
Modular
Foot-Osteosynthesis
System



 **Plating System**

Module ①

Module ②

Module ③

 **Cannulated System**

Module ①

Module ②

Module ③

Module ④



MONDE | foot

The M2 Modular Foot Osteosynthesis System offers a wide selection of plates, screws and all the required instrumentation for placement. The comprehensiveness of the system lends itself to a wide variety of fixation options for common indications in trauma and reconstructive surgery of the foot.

The modular design of the instrumentation allows the clinical facility to configure an instrumentation/implant offering exactly tailored to their surgical needs.

Other device features include a MCD screw head connection (MCD-Mondeal Contour Drive), forward and reverse cutting flutes on all screws and anatomically preformed plates.





M2 - Osteosynthesis System

Table of Contents

• Features, Advantages, Areas of Application	Page 3
• Overview Plating System, Cannulated System	Page 4
• Drills: Identification / Color Code	Page 5
• Plating System	
- Module 1: Plates	Page 6
- Module 1: Screws	Page 7 - 8
- Module 1: Instruments	Page 9
- Module 2: Plates	Page 10 - 11
- Module 2: Screws	Page 12 - 13
- Module 2: Instruments	Page 14
- Module 3: Plates	Page 15 - 17
- Module 3: Screws	Page 18 - 20
- Module 3: Instruments	Page 21 - 22
- General Instruments Plating System	Page 23 - 24
• Cannulated System	
- Module 1: Screws	Page 25
- Module 1: Instruments	Page 26
- Module 2: Screws	Page 27 - 28
- Module 2: Instruments	Page 29 - 30
- Module 3: Screws	Page 31 - 33
- Module 3: Instruments	Page 34 - 35
- Module 4: Screws	Page 36 - 38
- Module 4: Instruments	Page 39 - 44
- General Instruments Cannulated System	Page 45 - 48
• Container info	Page 49

Notice: The products are not shown in their original size.



The M2 System

The M2 System consists of two sub-systems:

- Plating System
Compatible Plate and Screw Elements
- Cannulated System
Cannulated Screws without Plates

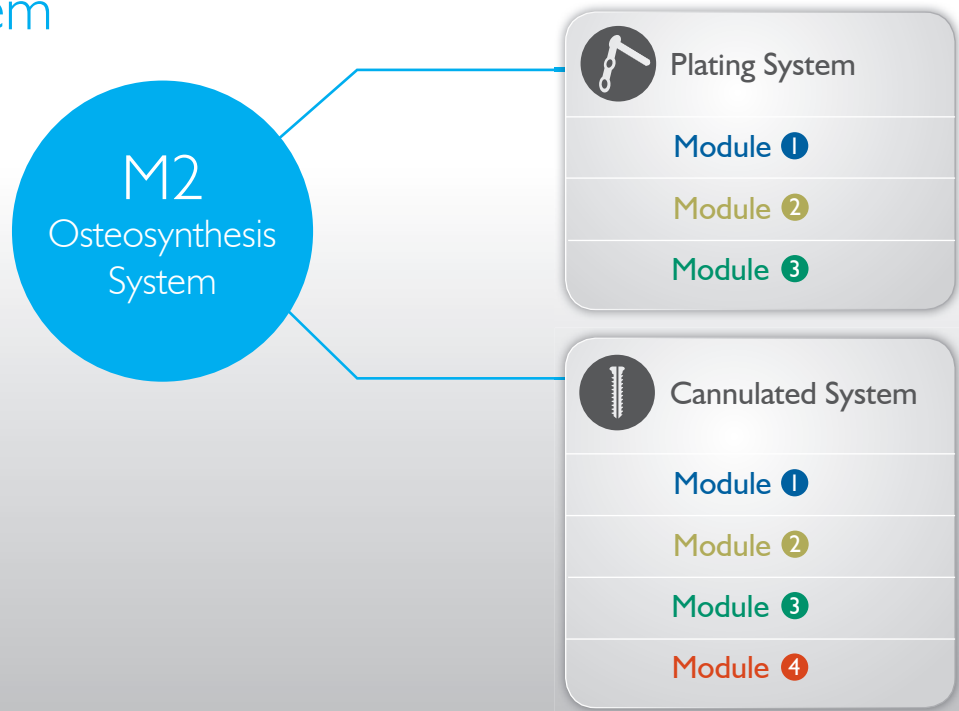

Features & Advantages of the M2 System

- Extensive selection of plates and screws for the foot/ankle within the M2 System.
- Plating System and Cannulated System each having a modular design to be used in conjunction or independent of each other.
- Numerous module configuration possibilities with the instrumentation.
- Screws are available in a “locking”, “non-locking” and “cannulated” version either fully or partially threaded.
- Secure screwdriver connection MCD (Mondeal Contour Drive) with all screws.
- Forward and reverse cutting flute design on all screws.
- Special plates already anatomically formed.
- All plates can be individually adapted with the available instruments e.g. the bending and cutting pliers.
- Innovative implant and instrument container system, individually configurable according to your requirements.
- Individual and detailed container identification possible based on the contents. The user can adjust and expand as needed.

Areas of Application

The M2 Modular Foot Osteosynthesis System offers a wide selection of plates, screws and all the required instrumentation for placement. The comprehensiveness of the system lends itself to a wide variety of fixation options for common indications in trauma and reconstructive surgery of the foot.

Such as:

- Lapidus
- MTPJ Fusion
- Hammer Toe
- Calcaneal Fracture
- Calcaneal Osteotomy
- Talar Navicular Fusion
- CC Fusion
- Lis Franc Fusion



Overview Sub-Systems

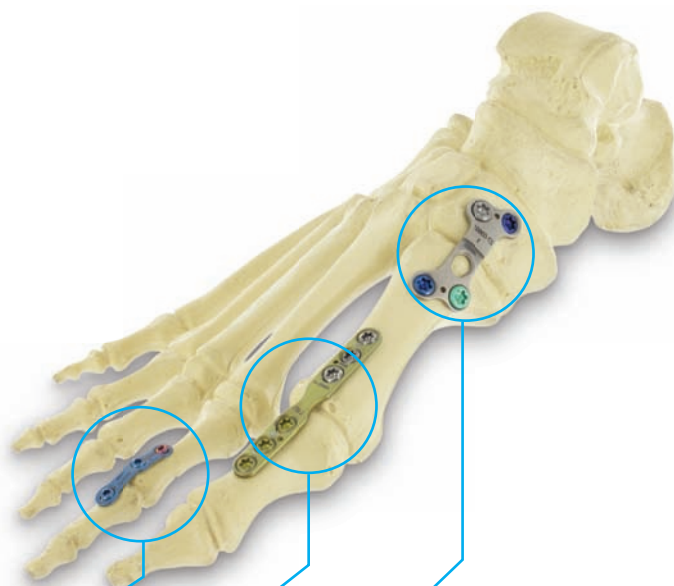

Plating System

		Module 1	Module 2	Module 3	
	Plates				
	Screws				
	Locking (fully threaded)				
	Non Locking (fully threaded)				
	Non Locking (partially threaded)				



Cannulated System

		Module 1	Module 2	Module 3	Module 4	
	Screws					
	Cannulated (fully threaded)					
	Cannulated (partially threaded)					
	Non Locking (fully threaded)					



Drills: Identification / Color Codes



Plating System

	Module 1	Module 2	Module 3	
Drill Color Code				
Screws	2.0 2.3	2.7 3.0	3.5 4.0 4.5	

Cannulated System

	Module 1	Module 2	Module 3	Module 4
Drill Color Code				
Screws	2.0 2.3	2.7 3.0	3.5 4.0 4.5	5.0 6.5 7.5



Module I (Packaging 1/ea.)

Plating System



Plates (Thickness 1.0 mm; Compression Path 1.0 mm)

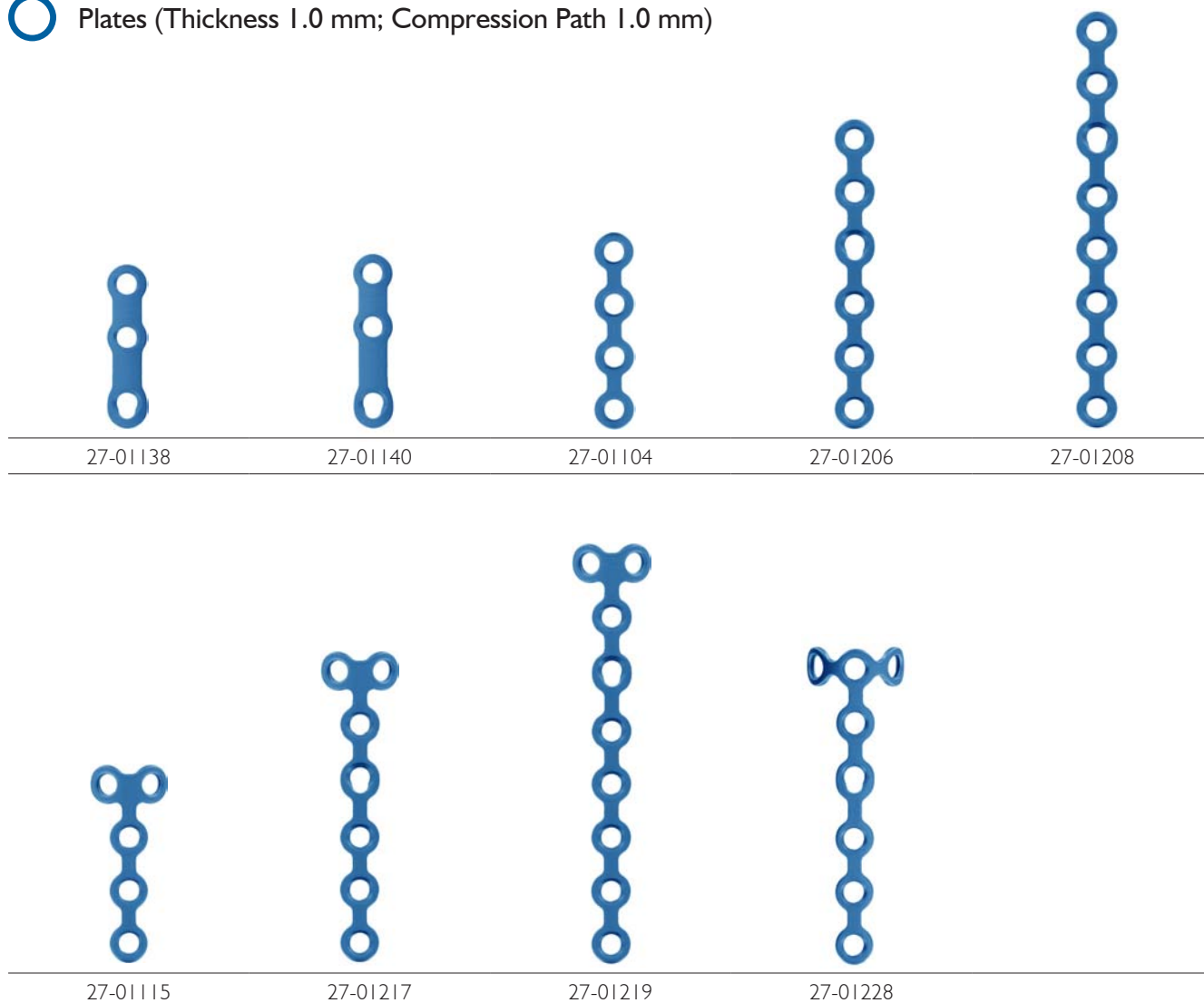

Art. No.	Description
27 - 01138	3-hole HT-Plate straight, small
27 - 01140	3-hole HT-Plate straight, large
27 - 01104	4-hole Plate straight
27 - 01206	6-hole Compression Plate straight
27 - 01208	8-hole Compression Plate straight
27 - 01115	5-hole T-Plate
27 - 01217	7-hole Compression T-Plate
27 - 01219	9-hole Compression T-Plate
27 - 01228	8-hole Compression T-Plate (optional)



2.0 Screws (Diameter 2.0 mm)



MCD Screw, locking, fully threaded

Art. No.	Diameter x Length
08 - 20106	2.0 x 6 mm
08 - 20108	2.0 x 8 mm
08 - 20110	2.0 x 10 mm
08 - 20112	2.0 x 12 mm
08 - 20114	2.0 x 14 mm
08 - 20116	2.0 x 16 mm
08 - 20118	2.0 x 18 mm
08 - 20120	2.0 x 20 mm
08 - 20122	2.0 x 22 mm
08 - 20124	2.0 x 24 mm
08 - 20126	2.0 x 26 mm



MCD Screw, non locking, fully threaded

Art. No.	Diameter x Length
08 - 20606	2.0 x 6 mm
08 - 20608	2.0 x 8 mm
08 - 20610	2.0 x 10 mm
08 - 20612	2.0 x 12 mm
08 - 20614	2.0 x 14 mm
08 - 20616	2.0 x 16 mm
08 - 20618	2.0 x 18 mm
08 - 20620	2.0 x 20 mm
08 - 20622	2.0 x 22 mm
08 - 20624	2.0 x 24 mm
08 - 20626	2.0 x 26 mm



2.3 Screws (Diameter 2.3 mm)



MCD Screw, locking, fully threaded

Art. No.	Diameter x Length
08 - 23106	2.3 x 6 mm
08 - 23108	2.3 x 8 mm
08 - 23110	2.3 x 10 mm
08 - 23112	2.3 x 12 mm
08 - 23114	2.3 x 14 mm
08 - 23116	2.3 x 16 mm
08 - 23118	2.3 x 18 mm
08 - 23120	2.3 x 20 mm
08 - 23122	2.3 x 22 mm
08 - 23124	2.3 x 24 mm
08 - 23126	2.3 x 26 mm



MCD Screw, non locking, fully threaded

Art. No.	Diameter x Length
08 - 23606	2.3 x 6 mm
08 - 23608	2.3 x 8 mm
08 - 23610	2.3 x 10 mm
08 - 23612	2.3 x 12 mm
08 - 23614	2.3 x 14 mm
08 - 23616	2.3 x 16 mm
08 - 23618	2.3 x 18 mm
08 - 23620	2.3 x 20 mm
08 - 23622	2.3 x 22 mm
08 - 23624	2.3 x 24 mm
08 - 23626	2.3 x 26 mm



Module I





Plating System



Instruments



Drills

 For Screws	Color Code	Art. No.	Type	Diameter x Length	Working Length (WL)	End
2.0		27-05100	Pilot Drill	1.4 x 120 mm	30 mm	AO
		27-05110	Gliding Hole Drill	2.1 x 80 mm	20 mm	AO
2.3		27-05101	Pilot Drill	1.7 x 130 mm	40 mm	AO
		27-05111	Gliding Hole Drill	2.4 x 80 mm	20 mm	AO



27-05150 Blade self-retaining - MCD M1, AO



27-06510 Sleeve for MCD M1 Blade

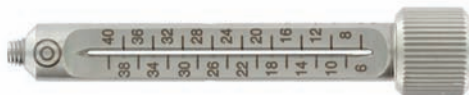

27-05140 Drill guide central M1



27-05141 Drill guide excentrical M1



Module 2 (Packaging: 1/ea.)

Plating System



Plates (Thickness 1.5 mm; Compression Path 1.5 mm)

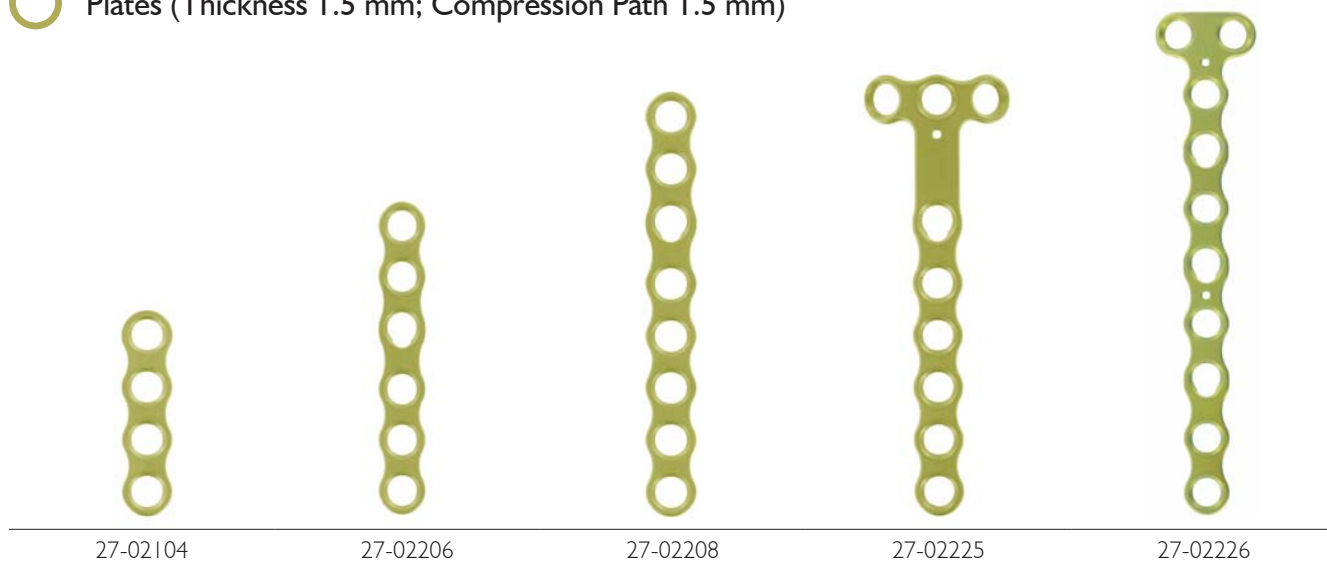

Art. No.	Description
27 - 02104	4-hole Plate straight
27 - 02206	6-hole Compression Plate
27 - 02208	8-hole Compression Plate
27 - 02225	9-hole Compression T-Plate
27 - 02226	10-hole Compression T-Plate
27 - 02555	Evans Plate
27 - 02535	MD-Plate, left
27 - 02536	MD-Plate, right
27 - 02320	4-hole H-Plate bar 20 mm
27 - 02322	4-hole H-Plate bar 22 mm
27 - 02130	4-hole L-Plate right
27 - 02131	4-hole L-Plate left



Module 2 (Packaging: 1/ea.)

Plating System



Plates (t=thickness; Compression Path 1.5 mm)



27-02451		27-02428	27-02435	t = 1,5 mm
27-02453	27-02449			t = 2.0 mm

Art. No.	Description
27 - 02451	6-hole Compression MTPJ-Plate 1.5 mm
27 - 02453	6-hole Compression MTPJ-Plate 2.0 mm
27 - 02449	4-hole Compression MTPJ-Plate 2.0 mm
27 - 02428	6-hole MTPJ-Plate, bar 28 mm 1.5 mm
27 - 02435	6-hole MTPJ-Plate, bar 35 mm 1.5 mm



27-02525 MRP-Plate, left

27-02526 MRP-Plate, right

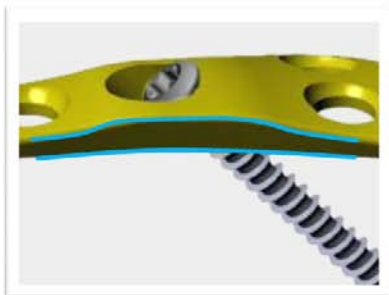

Reinforcement at fusion area for optimal power transmission



Integration of a hole with variable angulation for a compression screw (biomechanical benefit)

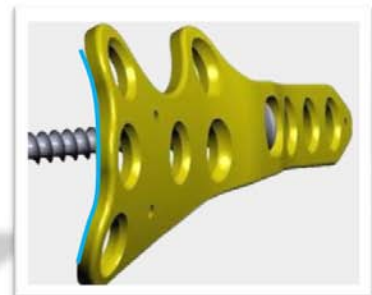

Pre-contoured plate design for correct application on the midfoot bone shape



2.7 Screws (Diameter 2.7 mm)



MCD Screw, locking, fully threaded

Art. No.	Diameter x Length
08 - 27108	2.7 x 8 mm
08 - 27110	2.7 x 10 mm
08 - 27112	2.7 x 12 mm
08 - 27114	2.7 x 14 mm
08 - 27116	2.7 x 16 mm
08 - 27118	2.7 x 18 mm
08 - 27120	2.7 x 20 mm
08 - 27122	2.7 x 22 mm
08 - 27124	2.7 x 24 mm
08 - 27126	2.7 x 26 mm
08 - 27128	2.7 x 28 mm
08 - 27130	2.7 x 30 mm



MCD Screw, non locking, fully threaded

Art. No.	Diameter x Length
08 - 27608	2.7 x 8 mm
08 - 27610	2.7 x 10 mm
08 - 27612	2.7 x 12 mm
08 - 27614	2.7 x 14 mm
08 - 27616	2.7 x 16 mm
08 - 27618	2.7 x 18 mm
08 - 27620	2.7 x 20 mm
08 - 27622	2.7 x 22 mm
08 - 27624	2.7 x 24 mm
08 - 27626	2.7 x 26 mm
08 - 27628	2.7 x 28 mm
08 - 27630	2.7 x 30 mm



3.0 Screws (Diameter 3.0 mm)



MCD Screw, locking, fully threaded

Art. No.	Diameter x Length
08 - 30108	3.0 x 8 mm
08 - 30110	3.0 x 10 mm
08 - 30112	3.0 x 12 mm
08 - 30114	3.0 x 14 mm
08 - 30116	3.0 x 16 mm
08 - 30118	3.0 x 18 mm
08 - 30120	3.0 x 20 mm
08 - 30122	3.0 x 22 mm
08 - 30124	3.0 x 24 mm
08 - 30126	3.0 x 26 mm
08 - 30128	3.0 x 28 mm
08 - 30130	3.0 x 30 mm
08 - 30132	3.0 x 32 mm
08 - 30134	3.0 x 34 mm
08 - 30136	3.0 x 36 mm
08 - 30138	3.0 x 38 mm
08 - 30140	3.0 x 40 mm



MCD Screw, non locking, fully threaded

Art. No.	Diameter x Length
08 - 30608	3.0 x 8 mm
08 - 30610	3.0 x 10 mm
08 - 30612	3.0 x 12 mm
08 - 30614	3.0 x 14 mm
08 - 30616	3.0 x 16 mm
08 - 30618	3.0 x 18 mm
08 - 30620	3.0 x 20 mm
08 - 30622	3.0 x 22 mm
08 - 30624	3.0 x 24 mm
08 - 30626	3.0 x 26 mm
08 - 30628	3.0 x 28 mm
08 - 30630	3.0 x 30 mm
08 - 30632	3.0 x 32 mm
08 - 30634	3.0 x 34 mm
08 - 30636	3.0 x 36 mm
08 - 30638	3.0 x 38 mm
08 - 30640	3.0 x 40 mm
08 - 30642	3.0 x 42 mm
08 - 30644	3.0 x 44 mm
08 - 30646	3.0 x 46 mm
08 - 30648	3.0 x 48 mm
08 - 30650	3.0 x 50 mm
08 - 30652	3.0 x 52 mm
08 - 30654	3.0 x 54 mm
08 - 30656	3.0 x 56 mm
08 - 30658	3.0 x 58 mm
08 - 30660	3.0 x 60 mm



Module 2

Plating System



Instruments



Drills

For Screws	Color Code	Art. No.	Type	Diameter x Length	Working Length (WL)	End
2.7		27-05200	Pilot Drill	1.8 x 132 mm	40 mm	AO
		27-05210	Gliding Hole Drill	2.8 x 80 mm	20 mm	AO
3.0		27-05201	Pilot Drill	2.1 x 132 mm	40 mm	AO
		27-05211	Gliding Hole Drill	3.1 x 80 mm	30 mm	AO



27-05250 Blade self-retaining - MCD M2, AO



27-06511 Sleeve for MCD M2 Blade



27-05240 Drill guide central M2



27-05241 Drill guide excentric M2

K-Wires



27-00910-150 K-Wire 1.0 x 150 mm



27-00910-150-G K-Wire 1.0 x 150 mm threaded



Module 3

(Packaging: 1/ea.)

Plating System



Plates (Thickness 2.0 mm; Compression Path 2.0 mm)

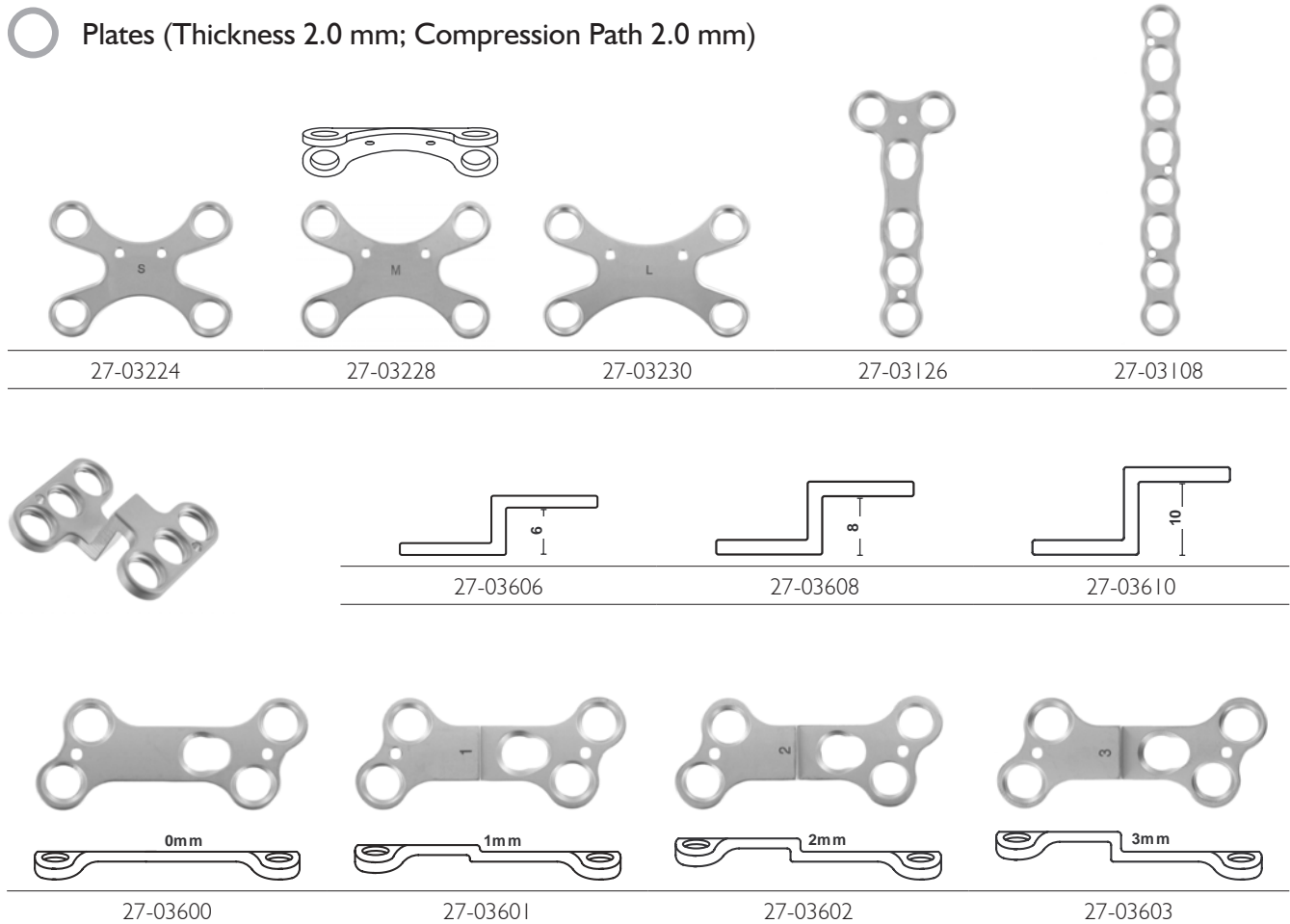

Art. No.	Description
27 - 03224	4-hole X-Plate 4.0 mm, small
27 - 03228	4-hole X-Plate 8.0 mm, medium
27 - 03230	4-hole X-Plate 10.0 mm, large
27 - 03126	6-hole Compression T-Plate
27 - 03108	8-hole Compression Plate straight
27 - 03606	6-hole DPS-Plate, step 6 mm
27 - 03608	6-hole DPS-Plate, step 8 mm
27 - 03610	6-hole DPS-Plate, step 10 mm
27 - 03600	5-hole Lapidus H-Plate, no step
27 - 03601	5-hole Lapidus H-Plate, step 1 mm
27 - 03602	5-hole Lapidus H-Plate, step 2 mm
27 - 03603	5-hole Lapidus H-Plate, step 3 mm



Module 3

(Packaging: 1/ea.)

Plating System



Plates (Thickness 1.5 mm; Compression Path 2.0 mm)

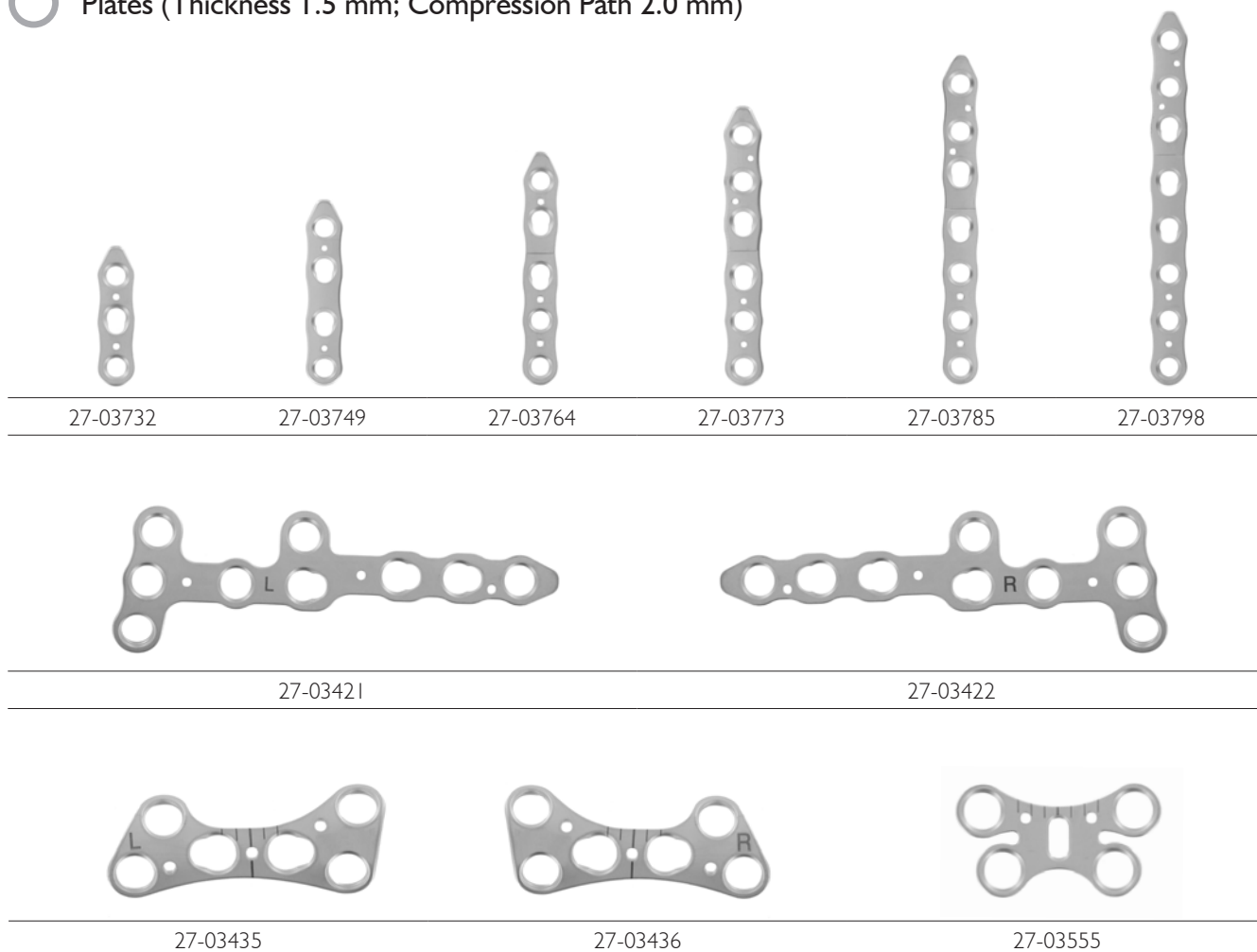

Art. No.	Description
27 - 03732	3-hole Compression Fibula-Plate
27 - 03749	4-hole Compression Fibula-Plate
27 - 03764	5-hole Compression Fibula-Plate
27 - 03773	6-hole Compression Fibula-Plate
27 - 03785	7-hole Compression Fibula-Plate
27 - 03798	8-hole Compression Fibula-Plate
27 - 03421	MCF-Plate, left
27 - 03422	MCF-Plate, right
27 - 03435	MD-Plate, left
27 - 03436	MD-Plate, right
27 - 03555	Evans Plate



Module 3 (Packaging: 1/ea.)

Plating System



Plates (Thickness 1.5 mm)

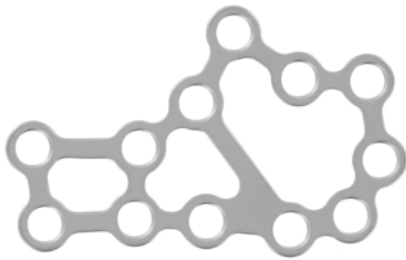

27-03502

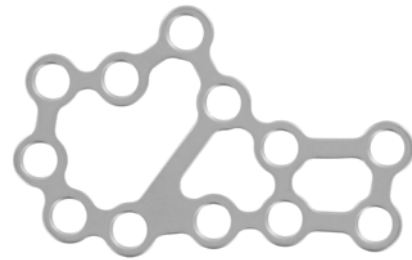

27-03501

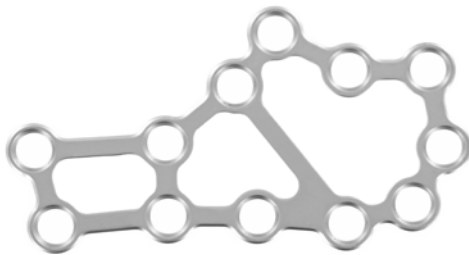

27-03504

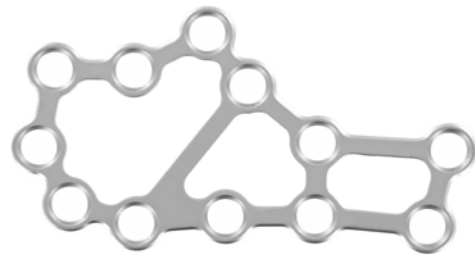

27-03503

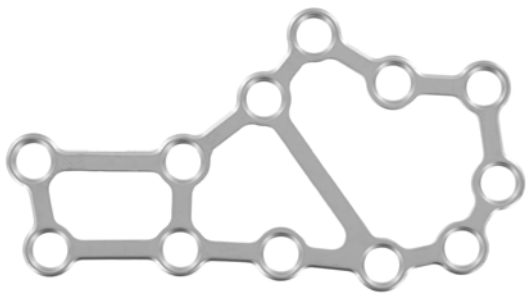

27-03506

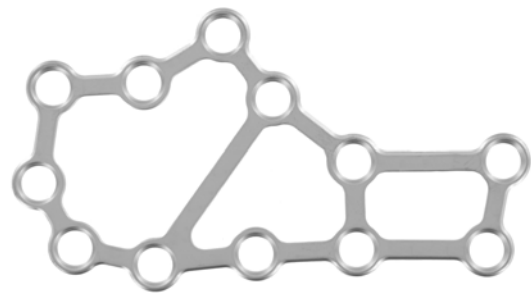

27-03505

Art. No.	Description
27 - 03502	12-hole Calcaneus Plate small, left
27 - 03501	12-hole Calcaneus Plate small, right
27 - 03504	12-hole Calcaneus Plate medium, left
27 - 03503	12-hole Calcaneus Plate medium, right
27 - 03506	12-hole Calcaneus Plate large, left
27 - 03505	12-hole Calcaneus Plate large, right



Module 3

(Packaging: 1/ea.)

Plating System



3.5 Screws (Diameter 3.5 mm)



MCD Screw, **locking**, fully threaded

Art. No.	Diameter x Length
08 - 35110	3.5 x 10 mm
08 - 35112	3.5 x 12 mm
08 - 35114	3.5 x 14 mm
08 - 35116	3.5 x 16 mm
08 - 35118	3.5 x 18 mm
08 - 35120	3.5 x 20 mm
08 - 35122	3.5 x 22 mm
08 - 35124	3.5 x 24 mm
08 - 35126	3.5 x 26 mm
08 - 35128	3.5 x 28 mm
08 - 35130	3.5 x 30 mm
08 - 35132	3.5 x 32 mm
08 - 35134	3.5 x 34 mm
08 - 35136	3.5 x 36 mm
08 - 35138	3.5 x 38 mm
08 - 35140	3.5 x 40 mm
08 - 35142	3.5 x 42 mm
08 - 35144	3.5 x 44 mm
08 - 35146	3.5 x 46 mm
08 - 35148	3.5 x 48 mm
08 - 35150	3.5 x 50 mm
08 - 35155	3.5 x 55 mm
08 - 35160	3.5 x 60 mm



MCD Screw, **non locking**, fully threaded

Art. No.	Diameter x Length
08 - 35610	3.5 x 10 mm
08 - 35612	3.5 x 12 mm
08 - 35614	3.5 x 14 mm
08 - 35616	3.5 x 16 mm
08 - 35618	3.5 x 18 mm
08 - 35620	3.5 x 20 mm
08 - 35622	3.5 x 22 mm
08 - 35624	3.5 x 24 mm
08 - 35626	3.5 x 26 mm
08 - 35628	3.5 x 28 mm
08 - 35630	3.5 x 30 mm
08 - 35632	3.5 x 32 mm
08 - 35634	3.5 x 34 mm
08 - 35636	3.5 x 36 mm
08 - 35638	3.5 x 38 mm
08 - 35640	3.5 x 40 mm
08 - 35642	3.5 x 42 mm
08 - 35644	3.5 x 44 mm
08 - 35646	3.5 x 46 mm
08 - 35648	3.5 x 48 mm
08 - 35650	3.5 x 50 mm
08 - 35655	3.5 x 55 mm
08 - 35660	3.5 x 60 mm



Module 3

(Packaging: 1/ea.)

Plating System



4.0 Screws (Diameter 4.0 mm)



MCD Screw, locking, fully threaded

Art. No.	Diameter x Length
08 - 40110	4.0 x 10 mm
08 - 40112	4.0 x 12 mm
08 - 40114	4.0 x 14 mm
08 - 40116	4.0 x 16 mm
08 - 40118	4.0 x 18 mm
08 - 40120	4.0 x 20 mm
08 - 40122	4.0 x 22 mm
08 - 40124	4.0 x 24 mm
08 - 40126	4.0 x 26 mm
08 - 40128	4.0 x 28 mm
08 - 40130	4.0 x 30 mm
08 - 40132	4.0 x 32 mm
08 - 40134	4.0 x 34 mm
08 - 40136	4.0 x 36 mm
08 - 40138	4.0 x 38 mm
08 - 40140	4.0 x 40 mm
08 - 40142	4.0 x 42 mm
08 - 40144	4.0 x 44 mm
08 - 40146	4.0 x 46 mm
08 - 40148	4.0 x 48 mm
08 - 40150	4.0 x 50 mm
08 - 40155	4.0 x 55 mm
08 - 40160	4.0 x 60 mm



MCD Screw, non locking, fully threaded

Art. No.	Diameter x Length
08 - 40610	4.0 x 10 mm
08 - 40612	4.0 x 12 mm
08 - 40614	4.0 x 14 mm
08 - 40616	4.0 x 16 mm
08 - 40618	4.0 x 18 mm
08 - 40620	4.0 x 20 mm
08 - 40622	4.0 x 22 mm
08 - 40624	4.0 x 24 mm
08 - 40626	4.0 x 26 mm
08 - 40628	4.0 x 28 mm
08 - 40630	4.0 x 30 mm
08 - 40632	4.0 x 32 mm
08 - 40634	4.0 x 34 mm
08 - 40636	4.0 x 36 mm
08 - 40638	4.0 x 38 mm
08 - 40640	4.0 x 40 mm
08 - 40642	4.0 x 42 mm
08 - 40644	4.0 x 44 mm
08 - 40646	4.0 x 46 mm
08 - 40648	4.0 x 48 mm
08 - 40650	4.0 x 50 mm
08 - 40655	4.0 x 55 mm
08 - 40660	4.0 x 60 mm



MCD Screw, non locking, partially threaded

Art. No.	Diameter x Length x Thread Length
08 - 40714	4.0 x 14 x 6 mm
08 - 40716	4.0 x 16 x 7 mm
08 - 40718	4.0 x 18 x 7.5 mm
08 - 40720	4.0 x 20 x 8 mm
08 - 40722	4.0 x 22 x 9 mm
08 - 40724	4.0 x 24 x 9.5 mm
08 - 40726	4.0 x 26 x 10 mm
08 - 40728	4.0 x 28 x 11 mm
08 - 40730	4.0 x 30 x 11.5 mm
08 - 40732	4.0 x 32 x 12 mm
08 - 40734	4.0 x 34 x 13 mm
08 - 40736	4.0 x 36 x 13.5 mm
08 - 40738	4.0 x 38 x 14 mm
08 - 40740	4.0 x 40 x 15 mm
08 - 40742	4.0 x 42 x 15.5 mm
08 - 40744	4.0 x 44 x 16 mm
08 - 40746	4.0 x 46 x 17 mm
08 - 40748	4.0 x 48 x 17.5 mm
08 - 40750	4.0 x 50 x 18 mm
08 - 40755	4.0 x 55 x 19 mm
08 - 40760	4.0 x 60 x 19.5 mm



Module 3

(Packaging: 1/ea.)

Plating System



4.5 Screws (Diameter 4.5 mm)



MCD Screw, non locking, fully threaded

Art. No.	Diameter x Length
08 - 45620	4.5 x 20 mm
08 - 45622	4.5 x 22 mm
08 - 45624	4.5 x 24 mm
08 - 45626	4.5 x 26 mm
08 - 45628	4.5 x 28 mm
08 - 45630	4.5 x 30 mm
08 - 45632	4.5 x 32 mm
08 - 45634	4.5 x 34 mm
08 - 45636	4.5 x 36 mm
08 - 45638	4.5 x 38 mm
08 - 45640	4.5 x 40 mm
08 - 45642	4.5 x 42 mm
08 - 45644	4.5 x 44 mm
08 - 45646	4.5 x 46 mm
08 - 45648	4.5 x 48 mm
08 - 45650	4.5 x 50 mm
08 - 45652	4.5 x 52 mm
08 - 45654	4.5 x 54 mm
08 - 45656	4.5 x 56 mm
08 - 45658	4.5 x 58 mm
08 - 45660	4.5 x 60 mm
08 - 45665	4.5 x 65 mm
08 - 45670	4.5 x 70 mm



Module 3







Plating System



Instruments



Drills

 For Screws	Color Code	Art. No.	Type	Diameter x Length	Working Length (WL)	End
3.5		27-05300	Pilot Drill	2.3 x 172 mm	60 mm	AO
		27-05310	Gliding Hole Drill	3.6 x 95 mm	45 mm	AO
4.0		27-05301	Pilot Drill	2.8 x 172 mm	60 mm	AO
		27-05311	Gliding Hole Drill	4.1 x 95 mm	45 mm	AO
4.5		27-05302	Pilot Drill	3.3 x 172 mm	70 mm	AO
		27-05312	Gliding Hole Drill	4.6 x 95 mm	50 mm	AO



Module 3

Plating System



Instruments



27-05350 Blade self-retaining - MCD M3, AO



27-06512 Sleeve for MCD M3 Blade



27-05340 Drill guide central M3

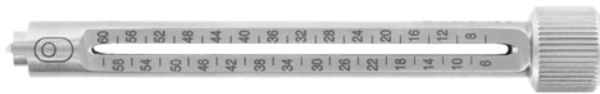

27-05341 Drill guide excentrical M3

K-Wires



27-00910-150 K-Wire 1.0 x 150 mm



27-00910-150-G K-Wire 1.0 x 150 mm threaded



Modules **1** **2** **3**

Plating System



General Instruments Plating System



28-20100 Sharp hook 15 cm



10-60030 Plate holding forceps curved



27-08041 Bending Instrument M2 / M3



27-08040 Bending Lever M1



27-08022 Screwdriver Handle, AO



27-08060 Bending Pliers with pin M1 / M2



27-08330 Bending Pliers with 2 pins for M2 Plates



27-08034 Depth measuring gauge M1 / M 2



27-08036 Depth measuring gauge M3



27-06507 Screws and K-Wire Measuring plate M1/M2/M3



27-08120 Plate Cutting Forceps M1 / M2



General Instruments Plating System (optional)



27-08340 Plate Cutting Forceps M3



27-08063 Saxena Bone Grafting Retractor



27-17588 Bone holding forceps serrated pointed



27-08023 T-handle with coupler, AO



27-08032 Forceps for picking up screws



27-08021 Screwdriver handle small, AO



27-08025 Screwdriver handle small, fixed, AO



Module I (Packaging: 1/ea.)

Cannulated System



2.0 Screws (Diameter 2.0 mm)



MCD Screw, Cannulated, fully threaded

Art. No.	Diameter x Length
08 - 20208	2.0 x 8 mm
08 - 20210	2.0 x 10 mm
08 - 20212	2.0 x 12 mm
08 - 20214	2.0 x 14 mm
08 - 20216	2.0 x 16 mm
08 - 20218	2.0 x 18 mm
08 - 20220	2.0 x 20 mm
08 - 20222	2.0 x 22 mm
08 - 20224	2.0 x 24 mm

2.3 Screws (Diameter 2.3 mm)



MCD Screw, Cannulated, fully threaded

Art. No.	Diameter x Length
08 - 23208	2.3 x 8 mm
08 - 23210	2.3 x 10 mm
08 - 23212	2.3 x 12 mm
08 - 23214	2.3 x 14 mm
08 - 23216	2.3 x 16 mm
08 - 23218	2.3 x 18 mm
08 - 23220	2.3 x 20 mm
08 - 23222	2.3 x 22 mm
08 - 23224	2.3 x 24 mm
08 - 23226	2.3 x 26 mm



Module I





Cannulated System



Instruments



Drills

 For Screws	Color Code	Art. No.	Type	Diameter x Length	Working Length (WL)	End
		27-05510	Gliding Hole Drill Cannulated	2.2 x 77 mm	27 mm	AO
		27-05511	Gliding Hole Drill Cannulated	2.5 x 77 mm	27 mm	AO



27-05550 Blade cannulated not self-retaining - MCD M1, AO



27-06510 Sleeve for MCD M1 Blade



27-05530 Countersink M1 cannulated AO

K-Wires



For Screws







27-00908-150 K-Wire 0.8 x 150 mm



Module 2 (Packaging: 1/ea.)

Cannulated System



2.7 Screws (Diameter 2.7 mm)



MCD Screw, Cannulated, fully threaded

Art. No.	Diameter x Length
08 - 27208	2.7 x 8 mm
08 - 27210	2.7 x 10 mm
08 - 27212	2.7 x 12 mm
08 - 27214	2.7 x 14 mm
08 - 27216	2.7 x 16 mm
08 - 27218	2.7 x 18 mm
08 - 27220	2.7 x 20 mm
08 - 27222	2.7 x 22 mm
08 - 27224	2.7 x 24 mm
08 - 27226	2.7 x 26 mm
08 - 27228	2.7 x 28 mm
08 - 27230	2.7 x 30 mm



Module 2 (Packaging: 1/ea.)

Cannulated System



3.0 Screws (Diameter 3.0 mm)



MCD Screw, Cannulated, fully threaded

Art. No.	Diameter x Length
08 - 30208	3.0 x 8 mm
08 - 30210	3.0 x 10 mm
08 - 30212	3.0 x 12 mm
08 - 30214	3.0 x 14 mm
08 - 30216	3.0 x 16 mm
08 - 30218	3.0 x 18 mm
08 - 30220	3.0 x 20 mm
08 - 30222	3.0 x 22 mm
08 - 30224	3.0 x 24 mm
08 - 30226	3.0 x 26 mm
08 - 30228	3.0 x 28 mm
08 - 30230	3.0 x 30 mm
08 - 30232	3.0 x 32 mm
08 - 30234	3.0 x 34 mm
08 - 30236	3.0 x 36 mm
08 - 30238	3.0 x 38 mm
08 - 30240	3.0 x 40 mm
08 - 30242	3.0 x 42 mm
08 - 30244	3.0 x 44 mm
08 - 30246	3.0 x 46 mm
08 - 30248	3.0 x 48 mm
08 - 30250	3.0 x 50 mm
08 - 30252	3.0 x 52 mm
08 - 30254	3.0 x 54 mm
08 - 30256	3.0 x 56 mm
08 - 30258	3.0 x 58 mm
08 - 30260	3.0 x 60 mm



MCD Screw, Cannulated, partially threaded

Art. No.	Diameter x Length x Thread Length
08 - 30314	3.0 x 14 x 6 mm
08 - 30316	3.0 x 16 x 7 mm
08 - 30318	3.0 x 18 x 7.5 mm
08 - 30320	3.0 x 20 x 8 mm
08 - 30322	3.0 x 22 x 9 mm
08 - 30324	3.0 x 24 x 9.5 mm
08 - 30326	3.0 x 26 x 10 mm
08 - 30328	3.0 x 28 x 11 mm
08 - 30330	3.0 x 30 x 11.5 mm
08 - 30332	3.0 x 32 x 12 mm
08 - 30334	3.0 x 34 x 13 mm
08 - 30336	3.0 x 36 x 13.5 mm
08 - 30338	3.0 x 38 x 14 mm
08 - 30340	3.0 x 40 x 15 mm
08 - 30342	3.0 x 42 x 16 mm
08 - 30344	3.0 x 44 x 16.5 mm
08 - 30346	3.0 x 46 x 17 mm
08 - 30348	3.0 x 48 x 17.5 mm
08 - 30350	3.0 x 50 x 18 mm
08 - 30352	3.0 x 52 x 18.5 mm
08 - 30354	3.0 x 54 x 19 mm
08 - 30356	3.0 x 56 x 19.5 mm
08 - 30358	3.0 x 58 x 20 mm
08 - 30360	3.0 x 60 x 20 mm

Washer



27-03902 Washer Module 2



Module 2







Cannulated System



Instruments



Drills

 For Screws	Color Code	Art. No.	Type	Diameter x Length	Working Length (WL)	End
2.7		27-05600	Pilot Drill Cannulated	1.8 x 90 mm	40 mm	AO
		27-05610	Gliding Hole Drill Cannulated	2.8 x 77 mm	27 mm	AO
		27-05620	Tap Cannulated	2.7 x 89 mm	14 mm	AO
3.0		27-05601	Pilot Drill Cannulated	2.1 x 110 mm	60 mm	AO
		27-05611	Gliding Hole Drill Cannulated	3.1 x 90 mm	40 mm	AO
		27-05621	Tap Cannulated	3.0 x 110 mm	14 mm	AO



Module 2

Cannulated System



Instruments



27-05650 Blade cannulated not self-retaining - MCD M2, AO



27-06511 Sleeve for MCD M2 Blade



27-05630 Countersink M2 cannulated AO

K-Wires



For Screws

2.7

3.0



27-00910-150 K-Wire 1.0 x 150 mm



27-00910-150-G K-Wire 1.0 x 150 mm threaded



Module 3 (Packaging: 1/ea.)

Cannulated System



3.5 Screws (Diameter 3.5 mm)



MCD Screw, Cannulated, fully threaded

Art. No.	Diameter x Length
08 - 35216	3.5 x 16 mm
08 - 35218	3.5 x 18 mm
08 - 35220	3.5 x 20 mm
08 - 35222	3.5 x 22 mm
08 - 35224	3.5 x 24 mm
08 - 35226	3.5 x 26 mm
08 - 35228	3.5 x 28 mm
08 - 35230	3.5 x 30 mm
08 - 35232	3.5 x 32 mm
08 - 35234	3.5 x 34 mm
08 - 35236	3.5 x 36 mm
08 - 35238	3.5 x 38 mm
08 - 35240	3.5 x 40 mm
08 - 35242	3.5 x 42 mm
08 - 35244	3.5 x 44 mm
08 - 35246	3.5 x 46 mm
08 - 35248	3.5 x 48 mm
08 - 35250	3.5 x 50 mm
08 - 35252	3.5 x 52 mm
08 - 35254	3.5 x 54 mm
08 - 35256	3.5 x 56 mm
08 - 35258	3.5 x 58 mm
08 - 35260	3.5 x 60 mm



Module 3 (Packaging: 1/ea.)

Cannulated System



4.0 Screws (Diameter 4.0 mm)



MCD Screw, Cannulated, fully threaded

Art. No.	Diameter x Length
08 - 40216	4.0 x 16 mm
08 - 40218	4.0 x 18 mm
08 - 40220	4.0 x 20 mm
08 - 40222	4.0 x 22 mm
08 - 40224	4.0 x 24 mm
08 - 40226	4.0 x 26 mm
08 - 40228	4.0 x 28 mm
08 - 40230	4.0 x 30 mm
08 - 40232	4.0 x 32 mm
08 - 40234	4.0 x 34 mm
08 - 40236	4.0 x 36 mm
08 - 40238	4.0 x 38 mm
08 - 40240	4.0 x 40 mm
08 - 40242	4.0 x 42 mm
08 - 40244	4.0 x 44 mm
08 - 40246	4.0 x 46 mm
08 - 40248	4.0 x 48 mm
08 - 40250	4.0 x 50 mm
08 - 40252	4.0 x 52 mm
08 - 40254	4.0 x 54 mm
08 - 40256	4.0 x 56 mm
08 - 40258	4.0 x 58 mm
08 - 40260	4.0 x 60 mm



MCD Screw, Cannulated, partially threaded

Art. No.	Diameter x Length x Thread Length
08 - 40316	4.0 x 16 x 7 mm
08 - 40318	4.0 x 18 x 7.5 mm
08 - 40320	4.0 x 20 x 8 mm
08 - 40322	4.0 x 22 x 9 mm
08 - 40324	4.0 x 24 x 9.5 mm
08 - 40326	4.0 x 26 x 10 mm
08 - 40328	4.0 x 28 x 11 mm
08 - 40330	4.0 x 30 x 11.5 mm
08 - 40332	4.0 x 32 x 12 mm
08 - 40334	4.0 x 34 x 13 mm
08 - 40336	4.0 x 36 x 13.5 mm
08 - 40338	4.0 x 38 x 14 mm
08 - 40340	4.0 x 40 x 15 mm
08 - 40342	4.0 x 42 x 15.5 mm
08 - 40344	4.0 x 44 x 16 mm
08 - 40346	4.0 x 46 x 17 mm
08 - 40348	4.0 x 48 x 17.5 mm
08 - 40350	4.0 x 50 x 18 mm
08 - 40352	4.0 x 52 x 18.5 mm
08 - 40354	4.0 x 54 x 19 mm
08 - 40356	4.0 x 56 x 19.5 mm
08 - 40358	4.0 x 58 x 20 mm
08 - 40360	4.0 x 60 x 20 mm



Module 3 (Packaging: 1/ea.)

Cannulated System



4.5 Screws (Diameter 4.5 mm)



MCD Screw, Cannulated, fully threaded

Art. No.	Diameter x Length
08 - 45216	4.5 x 16 mm
08 - 45218	4.5 x 18 mm
08 - 45220	4.5 x 20 mm
08 - 45222	4.5 x 22 mm
08 - 45224	4.5 x 24 mm
08 - 45226	4.5 x 26 mm
08 - 45228	4.5 x 28 mm
08 - 45230	4.5 x 30 mm
08 - 45232	4.5 x 32 mm
08 - 45234	4.5 x 34 mm
08 - 45236	4.5 x 36 mm
08 - 45238	4.5 x 38 mm
08 - 45240	4.5 x 40 mm
08 - 45242	4.5 x 42 mm
08 - 45244	4.5 x 44 mm
08 - 45246	4.5 x 46 mm
08 - 45248	4.5 x 48 mm
08 - 45250	4.5 x 50 mm
08 - 45255	4.5 x 55 mm
08 - 45260	4.5 x 60 mm
08 - 45265	4.5 x 65 mm
08 - 45270	4.5 x 70 mm



MCD Screw, Cannulated, partially threaded

Art. No.	Diameter x Length x Thread Length
08 - 45316	4.5 x 16 x 7 mm
08 - 45318	4.5 x 18 x 7.5 mm
08 - 45320	4.5 x 20 x 8 mm
08 - 45322	4.5 x 22 x 9 mm
08 - 45324	4.5 x 24 x 9.5 mm
08 - 45326	4.5 x 26 x 10 mm
08 - 45328	4.5 x 28 x 11 mm
08 - 45330	4.5 x 30 x 11.5 mm
08 - 45332	4.5 x 32 x 12 mm
08 - 45334	4.5 x 34 x 13 mm
08 - 45336	4.5 x 36 x 13.5 mm
08 - 45338	4.5 x 38 x 14 mm
08 - 45340	4.5 x 40 x 15 mm
08 - 45342	4.5 x 42 x 15.5 mm
08 - 45344	4.5 x 44 x 16 mm
08 - 45346	4.5 x 46 x 17 mm
08 - 45348	4.5 x 48 x 17.5 mm
08 - 45350	4.5 x 50 x 18 mm
08 - 45355	4.5 x 55 x 19.5 mm
08 - 45360	4.5 x 60 x 20 mm
08 - 45365	4.5 x 65 x 20 mm
08 - 45370	4.5 x 70 x 20 mm

Washer



27-03903 Washer Module 3



Module 3

Cannulated System



Instruments



Drills

 For Screws	Color Code	Art. No.	Type	Diameter x Length	Working Length (WL)	End
3.5		27-05700	Pilot Drill Cannulated	2.3 x 124 mm	75 mm	AO
		27-05710	Gliding Hole Drill Cannulated	3.6 x 98 mm	50 mm	AO
		27-05720	Tap Cannulated	3.5 x 124 mm	14 mm	AO
4.0		27-05701	Pilot Drill Cannulated	2.8 x 124 mm	75 mm	AO
		27-05711	Gliding Hole Drill Cannulated	4.1 x 98 mm	50 mm	AO
		27-05721	Tap Cannulated	4.0 x 124 mm	14 mm	AO
4.5		27-05702	Pilot Drill Cannulated	3.3 x 124 mm	75 mm	AO
		27-05712	Gliding Hole Drill Cannulated	4.6 x 98 mm	50 mm	AO
		27-05722	Tap Cannulated	4.5 x 124 mm	14 mm	AO



Module 3

Cannulated System



Instruments



27-05750 Blade cannulated not self-retaining - MCD M3, AO



27-06512 Sleeve for MCD M3 Blade



27-05730 Countersink M3 cannulated AO

K-Wires



For Screws

3.5

4.0



27-00915-150 K-Wire 1.5 x 150 mm



27-00915-150-G K-Wire 1.5 x 150 mm threaded



For Screws

4.5



27-00920-150 K-Wire 2.0 x 150 mm



27-00920-150-G K-Wire 2.0 x 150 mm threaded



5.0 Screws (Diameter 5.0 mm)



MCD Screw, non locking, fully threaded

Art. No.	Diameter x Length
08 - 50630	5.0 x 30 mm
08 - 50632	5.0 x 32 mm
08 - 50634	5.0 x 34 mm
08 - 50636	5.0 x 36 mm
08 - 50638	5.0 x 38 mm
08 - 50640	5.0 x 40 mm
08 - 50642	5.0 x 42 mm
08 - 50644	5.0 x 44 mm
08 - 50646	5.0 x 46 mm
08 - 50648	5.0 x 48 mm
08 - 50650	5.0 x 50 mm
08 - 50652	5.0 x 52 mm
08 - 50654	5.0 x 54 mm
08 - 50656	5.0 x 56 mm
08 - 50658	5.0 x 58 mm
08 - 50660	5.0 x 60 mm



MCD Screw, Cannulated, fully threaded

Art. No.	Diameter x Length
08 - 50230	5.0 x 30 mm
08 - 50232	5.0 x 32 mm
08 - 50234	5.0 x 34 mm
08 - 50236	5.0 x 36 mm
08 - 50238	5.0 x 38 mm
08 - 50240	5.0 x 40 mm
08 - 50242	5.0 x 42 mm
08 - 50244	5.0 x 44 mm
08 - 50246	5.0 x 46 mm
08 - 50248	5.0 x 48 mm
08 - 50250	5.0 x 50 mm
08 - 50252	5.0 x 52 mm
08 - 50254	5.0 x 54 mm
08 - 50256	5.0 x 56 mm
08 - 50258	5.0 x 58 mm
08 - 50260	5.0 x 60 mm
08 - 50265	5.0 x 65 mm
08 - 50270	5.0 x 70 mm
08 - 50275	5.0 x 75 mm
08 - 50280	5.0 x 80 mm
08 - 50285	5.0 x 85 mm
08 - 50290	5.0 x 90 mm



MCD Screw, Cannulated, partially threaded

Art. No.	Diameter x Length x Thread Length
08 - 50330	5.0 x 30 x 10 mm
08 - 50332	5.0 x 32 x 10.5 mm
08 - 50334	5.0 x 34 x 11.5 mm
08 - 50336	5.0 x 36 x 12 mm
08 - 50338	5.0 x 38 x 12.5 mm
08 - 50340	5.0 x 40 x 13.5 mm
08 - 50342	5.0 x 42 x 14 mm
08 - 50344	5.0 x 44 x 14.5 mm
08 - 50346	5.0 x 46 x 15.5 mm
08 - 50348	5.0 x 48 x 16 mm
08 - 50350	5.0 x 50 x 16.5 mm
08 - 50352	5.0 x 52 x 17.5 mm
08 - 50354	5.0 x 54 x 18 mm
08 - 50356	5.0 x 56 x 18.5 mm
08 - 50358	5.0 x 58 x 19.5 mm
08 - 50360	5.0 x 60 x 20 mm
08 - 50365	5.0 x 65 x 20 mm
08 - 50370	5.0 x 70 x 20 mm
08 - 50375	5.0 x 75 x 20 mm
08 - 50380	5.0 x 80 x 20 mm
08 - 50385	5.0 x 85 x 20 mm
08 - 50390	5.0 x 90 x 20 mm



Module 4

(Packaging: 1/ea.)

Cannulated System



6.5 Screws (Diameter 6.5 mm)



MCD Screw, non locking, fully threaded

Art. No.	Diameter x Length
08 - 65650	6.5 x 50 mm
08 - 65655	6.5 x 55 mm
08 - 65660	6.5 x 60 mm
08 - 65665	6.5 x 65 mm
08 - 65670	6.5 x 70 mm
08 - 65675	6.5 x 75 mm
08 - 65680	6.5 x 80 mm
08 - 65685	6.5 x 85 mm
08 - 65690	6.5 x 90 mm
08 - 65695	6.5 x 95 mm
08 - 65696	6.5 x 100 mm
08 - 65697	6.5 x 105 mm
08 - 65698	6.5 x 110 mm
08 - 65699	6.5 x 115 mm
08 - 65700	6.5 x 120 mm



MCD Screw, Cannulated, fully threaded

Art. No.	Diameter x Length
08 - 65250	6.5 x 50 mm
08 - 65255	6.5 x 55 mm
08 - 65260	6.5 x 60 mm
08 - 65265	6.5 x 65 mm
08 - 65270	6.5 x 70 mm
08 - 65275	6.5 x 75 mm
08 - 65280	6.5 x 80 mm
08 - 65285	6.5 x 85 mm
08 - 65290	6.5 x 90 mm
08 - 65295	6.5 x 95 mm
08 - 65296	6.5 x 100 mm
08 - 65297	6.5 x 105 mm
08 - 65298	6.5 x 110 mm
08 - 65299	6.5 x 115 mm
08 - 65300	6.5 x 120 mm



MCD Screw, Cannulated, partially threaded

Art. No.	Diameter x Length x Thread Length
08 - 65350	6.5 x 50 x 17 mm
08 - 65355	6.5 x 55 x 18 mm
08 - 65360	6.5 x 60 x 20 mm
08 - 65365	6.5 x 65 x 20 mm
08 - 65370	6.5 x 70 x 20 mm
08 - 65375	6.5 x 75 x 20 mm
08 - 65380	6.5 x 80 x 20 mm
08 - 65385	6.5 x 85 x 20 mm
08 - 65390	6.5 x 90 x 20 mm
08 - 65395	6.5 x 95 x 20 mm
08 - 65396	6.5 x 100 x 20 mm
08 - 65397	6.5 x 105 x 20 mm
08 - 65398	6.5 x 110 x 20 mm
08 - 65399	6.5 x 115 x 20 mm
08 - 65400	6.5 x 120 x 20 mm



MCD Screw, Cannulated, partially threaded

Art. No.	Diameter x Length x Thread Length
08 - 65450	6.5 x 50 x 25 mm
08 - 65455	6.5 x 55 x 27 mm
08 - 65460	6.5 x 60 x 30 mm
08 - 65465	6.5 x 65 x 35 mm
08 - 65470	6.5 x 70 x 35 mm
08 - 65475	6.5 x 75 x 35 mm
08 - 65480	6.5 x 80 x 35 mm
08 - 65485	6.5 x 85 x 35 mm
08 - 65490	6.5 x 90 x 35 mm
08 - 65495	6.5 x 95 x 35 mm
08 - 65496	6.5 x 100 x 35 mm
08 - 65497	6.5 x 105 x 35 mm
08 - 65498	6.5 x 110 x 35 mm
08 - 65499	6.5 x 115 x 35 mm
08 - 65500	6.5 x 120 x 35 mm



Module 4

(Packaging: 1/ea.)

Cannulated System



7.5 Screws (Diameter 7.5 mm)



MCD Screw, Cannulated, partially threaded

Art. No.	Diameter x Length x Thread Length
08 - 75355	7.5 x 55 x 20 mm
08 - 75360	7.5 x 60 x 20 mm
08 - 75365	7.5 x 65 x 20 mm
08 - 75370	7.5 x 70 x 20 mm
08 - 75375	7.5 x 75 x 20 mm
08 - 75380	7.5 x 80 x 20 mm
08 - 75385	7.5 x 85 x 20 mm
08 - 75390	7.5 x 90 x 20 mm
08 - 75395	7.5 x 95 x 20 mm
08 - 75396	7.5 x 100 x 20 mm
08 - 75397	7.5 x 105 x 30 mm
08 - 75398	7.5 x 110 x 30 mm
08 - 75399	7.5 x 115 x 35 mm
08 - 75400	7.5 x 120 x 35 mm
08 - 75401	7.5 x 125 x 35 mm
08 - 75402	7.5 x 130 x 35 mm
08 - 75403	7.5 x 135 x 35 mm
08 - 75404	7.5 x 140 x 35 mm

Washer



27-03904 Washer Module 4







Module 4

Cannulated System



Instruments (non locking)

 Drills

 For Screws	Color Code	Art. No.	Type	Diameter x Length	Working Length (WL)	End
5.0		27-05400	Pilot Drill	3.4 x 120 mm	60 mm	AO
		27-05410	Gliding Hole Drill	5.1 x 100 mm	40 mm	AO
6.5		27-05403	Pilot Drill	4.7 x 170 mm	120 mm	AO
		27-05413	Gliding Hole Drill	6.6 x 140 mm	80 mm	AO



27-05450 Blade self-retaining - MCD M4, AO



27-06513 Sleeve for MCD M4 Blade



Module 4









Cannulated System



Instruments (Cannulated)



Drills

 For Screws	Color Code	Art. No.	Type	Diameter x Length	Working Length (WL)	End
5.0		27-06000	Pilot Drill Cannulated	3.4 x 138 mm	90 mm	AO
		27-06050	Gliding Hole Drill Cannulated	5.1 x 106 mm	60 mm	AO
		27-06100	Tap Cannulated	5.0 x 138 mm	18 mm	AO
6.5		27-06015	Pilot Drill Cannulated	4.7 x 170 mm	50 mm	Jakobs Quick Coupler
		27-06065	Gliding Hole Drill Cannulated	6.6 x 170 mm	40 mm	Jakobs Quick Coupler
		27-06115	Tap Cannulated	6.5 x 170 mm	20 mm	Jakobs Quick Coupler
7.5		27-06025	Pilot Drill Cannulated	4.7 x 170 mm	50 mm	Jakobs Quick Coupler
		27-06125	Tap Cannulated	7.5 x 170 mm	30 mm	Jakobs Quick Coupler



Module 4

Cannulated System



Instruments (Cannulated)



27-06250 MCD Blade M4 cannulated for 200 mm K-Wire, not self-retaining, for Jacobs Quick Coupler



27-06150 Countersink M4 cannulated L=170 mm



27-08026 Quick Coupler for blades / drills M4 to AO



27-06513 Sleeve for MCD M4 Blade



Module 4

Cannulated System



K-Wires

 For Screws **5.0**



27-00920-200 K-Wire 2.0 x 200 mm

27-00920-200-G K-Wire 2.0 x 200 mm threaded

 For Screws **6.5** **7.5**



27-00928-200 K-Wire 2.8 x 200 mm

27-00928-200-G K-Wire 2.8 x 200 mm threaded



Module 4







Cannulated System



Instruments (Cannulated) optional



Drills

 For Screws	Color Code	Art. No.	Type	Diameter x Length	Working Length (WL)	End
6.5		27-06016	Pilot Drill Cannulated	4.7 x 270 mm	50 mm	Jakobs Quick Coupler
		27-06017	Pilot Drill Cannulated	4.7 x 420 mm	50 mm	Jakobs Quick Coupler
		27-06066	Gliding Hole Drill Cannulated	6.6 x 270 mm	40 mm	Jakobs Quick Coupler
		27-06067	Gliding Hole Drill Cannulated	6.6 x 420 mm	40 mm	Jakobs Quick Coupler
		27-06116	Tap Cannulated	6.5 x 270 mm	20 mm	Jakobs Quick Coupler
		27-06117	Tap Cannulated	6.5 x 420 mm	20 mm	Jakobs Quick Coupler
7.5		27-06026	Pilot Drill Cannulated	4.7 x 270 mm	50 mm	Jakobs Quick Coupler
		27-06027	Pilot Drill Cannulated	4.7 x 420 mm	50 mm	Jakobs Quick Coupler
		27-06126	Tap Cannulated	7.5 x 270 mm	30 mm	Jakobs Quick Coupler
		27-06127	Tap Cannulated	7.5 x 420 mm	30 mm	Jakobs Quick Coupler

**Module 4**

Cannulated System

**Instruments (Cannulated) optional**

27-06151 Countersink M4 cannulated L=270 mm



27-06152 Countersink M4 cannulated L=420 mm



27-06251 MCD Blade M4 cannulated for 300 mm K-Wire, not self-retaining, for Jacobs Quick Coupler



27-06252 MCD Blade M4 cannulated for 450 mm K-Wire, not self-retaining, for Jacobs Quick Coupler



Modules **1** **2** **3** **4**

Cannulated System



General Instruments Cannulated System



27-06500 Depth gauge for K-Wire 150 mm M1 / M2



27-06501 Depth gauge for K-Wire 150 mm M3

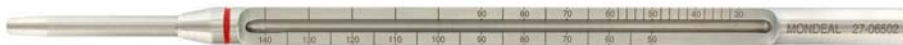

27-06502 Depth gauge for K-Wire 200 mm M4



27-08022 Screwdriver Handle, AO



27-08032 Forceps for picking up screws



27-06508 Screws and K-Wire Measuring plate, M4



Modules **1** **2** **3** **4**

Cannulated System



General Instruments Cannulated System (optional)



27-06503 Depth gauge for K-Wire 300 mm M4



27-06504 Depth gauge for K-Wire 450 mm M4



27-08037 Depth measuring gauge M4, working range 30 - 140 mm

K-Wires



For Screws

6.5

7.5



27-00928-300 K-Wire 2.8 x 300 mm



27-00928-300-G K-Wire 2.8 x 300 mm threaded



27-00928-450 K-Wire 2.8 x 450 mm



27-00928-450-G K-Wire 2.8 x 450 mm threaded



Modules **1** **2** **3** **4**

Cannulated System



General Instruments Cannulated System (optional)



27-08021 Screwdriver Handle small, AO



27-08025 Screwdriver Handle small, fixed, AO



27-08023 T-Handle with coupler, AO



General Instruments Cannulated System (extra)



27-03916 Reamer 16 mm konvex AO



27-04016 Reamer 16 mm konkave AO



27-03919 Reamer 19 mm konvex AO



27-04019 Reamer 19 mm konkave AO



27-03922 Reamer 22 mm konvex AO



27-04022 Reamer 22 mm konkave AO

K-Wires



27-00920-150 K-Wire 2.0 x 150 mm



27-00920-150-G K-Wire 2.0 x 150 mm threaded



MONDEAL | *foot*

The M2 modular design principle gives the user countless configuration options for custom combinations of screws, plates and instruments. This is also reflected in the modular container system. The container components are combined depending on the user's preference and configuration of the individual elements.



MONDEAL | *foot*

High Quality
Implants

Made by MONDEAL

We reserve the right to make catalog and design changes arising from further developments and modifications. Pictures, product descriptions and texts are the property of MONDEAL Medical Systems GmbH. Further use and reproduction by Third Parties requires written consent from MONDEAL Medical Systems GmbH. All rights reserved! Note: Responsibility for the selection of the patient, for adequate training as well as the decision as to the choice and use of the implants, a post-operative removal or retention of implants is the sole decision of the surgeon. All brands and logos referred to in this brochure, registered by Third Parties, are subject without restriction to the legal provisions currently in force and to the rights of ownership of the respective registered owner.

© 2013 - MONDEAL Medical Systems GmbH

