

**Urologie**  
Urology

Wir behalten uns vor, Änderungen und Verbesserungen, durchzuführen und die Instrumente und Geräte ohne besonderen Hinweis in der modifizierten Ausführung auszuliefern.

Die Verwendung dieses Kataloges zu anderen Zwecken als ausschließlich der zum Vertrieb von CM Produkten ist untersagt. Zuwiderhandlungen werden rechtlich geahndet. Der Nachdruck, auch auszugsweise, ist verboten.

We reserve the right of technical modifications and improvements and to supply the instruments and apparatus without specific indication in the modified finish.

The use of this catalogue is restricted to actions necessary for selling original CM products. The use for any purpose other than selling original CM products is Reprinting, even partially, is not allowed.

**CM Instrumente GmbH**  
**Gänsäcker 56**  
**D-78532 Tuttlingen, Germany**  
**Tel: +49 (0) 7462-20420-70**  
**Fax: +49 (0) 7462-20420-62**  
**email: [info@cm-instrumente.de](mailto:info@cm-instrumente.de)**  
**Web: [www.cm-instrumente.de](http://www.cm-instrumente.de)**

---

Cysto-Urethroskopie / Cysto-Urethroscopy	Seite / Page	4 - 14
Resektoskopie / Resectoscopy	Seite / Page	15 - 28
Urethotomie / Urethrotomy	Seite / Page	29 - 33
Urethro-Renoskopie / Urethro-Renoscopy	Seite / Page	34 - 35
Kinder Endo-Urologie / Pediatric Endo-Urology	Seite / Page	36 - 40
Metallkatheter / Metal Catheters	Seite / Page	41
Penisklemmen / Penis Clamps	Seite / Page	42
Dilatationsbougies / Dilating Bougies	Seite / Page	43 - 44

# Cysto-Urethroskopie

## Cysto-Urethroscopy

### Endoskope Ø 4,0 mm Endoscopes Ø 4,0 mm



JB-430-00	JB-430-12	JB-430-30	JB-430-70	
0°	12°	30°	70°	Blickrichtung / Direction of view
301 mm	301 mm	301 mm	301 mm	Arbeitslänge / Working length

### Schäfte mit 2 starren Hähnen Sheaths with 2 fixed stopcocks

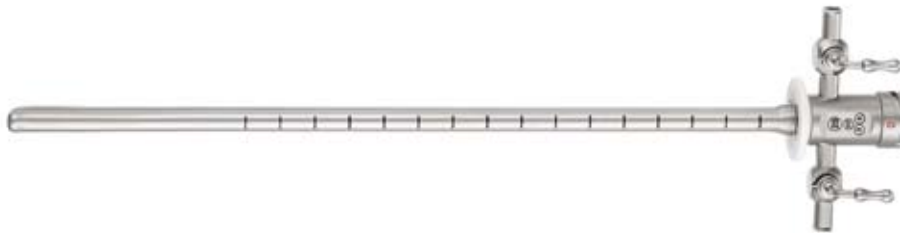

JD-117-01*	JD-119-01	JD-211-01	JD-213-01	JD-215-01	
17 Charr.	19 Charr.	21 Charr.	23 Charr.	25 Charr.	Durchmesser / Diameter
1x5 Carr.	1x6, 2x5 Carr.	1x7, 2x5 Carr.	1x10, 2x7 Carr.	1x10, 2x8 Carr.	Durchlass / Capacity
gelb / yellow	grün / green	rot / red	blau / blue	weiß / white	Kennfarbe / Colour code

\* nur zur Verwendung mit JD-510-01 und JD-511-01  
for use with JD-510-01 and JD-511-01 only

### Schäfte mit Zentralhahn Sheaths with central valve



JD-117-02	JD-119-02	JD-211-02	JD-213-02	JD-215-02	
17 Charr.	19 Charr.	21 Charr.	23 Charr.	25 Charr.	Durchmesser / Diameter
1x5 Carr.	1x6, 2x5 Carr.	1x7, 2x5 Carr.	1x10, 2x7 Carr.	1x10, 2x8 Carr.	Durchlass / Capacity
gelb / yellow	grün / green	rot / red	blau / blue	weiß / white	Kennfarbe / Colour code

\* nur zur Verwendung mit JD-510-01 und JD-511-01  
for use with JD-510-01 and JD-511-01 only

**Endoskopbrücken**  
**Endoscope Bridges**



**JD-510-01**

Diagnose  
 Diagnostic



**JD-510-02**

1 Instrumenten-Kanal  
 1 Instrument channel



**JD-510-03**

2 Instrumenten-Kanäle  
 2 Instrument channel

**Arbeitseinsatz mit Albarran-Lenkhebel**  
**Working Element with Albarran deflector**

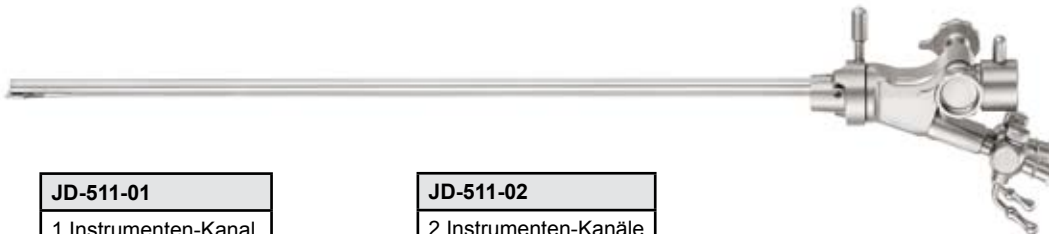

**JD-511-01**

1 Instrumenten-Kanal  
 1 Instrument channel

**JD-511-02**

2 Instrumenten-Kanäle  
 2 Instrument channel

**Cystoskop-Adapter**  
**Cystoscope Adapter**



**JD-512-52**

Dichtungsadapterstück für Schäfte zur Verwendung in der Urethroskopie bei Frauen  
 Sealing adapter for sheaths for use in female urethroscopy

### Obturatoren für Cysto-Urethroskopschäft

### Obturator for Cysto-Urethroscope Sheaths

#### Standardobturator

#### Standard Obturator



JD-117-05	JD-119-05	JD-211-05	JD-213-05	JD-215-05
17 Charr.	19 Charr.	21 Charr.	23 Charr.	25 Charr.

#### Sichtobturator

#### Visual Obturator



JD-117-06	JD-119-06	JD-211-06	JD-213-06	JD-215-06
17 Charr.	19 Charr.	21 Charr.	23 Charr.	25 Charr.



**Optische Instrumente für Cysto-Urethroskope für Schäfte von  
 19 bis 25 Charr.und Endoskope mit 4,0 mm**  
**Optical Instruments for Cysto-Urethrosopes for sheaths from  
 19 up 25 Fr. and endoscopes with 4,0 mm**



**JD-512-01**  
 Probeexzisionszange, doppelbeweglich, für Endoskope 0° / 12° / (30°)  
 Biopsy forceps, double action, for endoscopes 0° / 12° / (30°)



**JD-512-04**  
 Probeexzisionszange, durchschneidend, für Endoskope 70°  
 Biopsy forceps, through cutting, for endoscopes 70°



**JD-512-02**  
 Faßzange, doppelbeweglich, für Endoskope 0° / 12°  
 Grasping forceps, double action, for endoscopes 0° / 12°



**JD-512-05**  
 Probeexzisionszange, doppelbeweglich, für Endoskope 12° / 30°  
 Biopsy forceps, double action, for endoscopes 12° / 30°



**JD-512-03**  
 Probeexzisionszange, durchschneidend, für Endoskope 0° / 12°  
 Biopsy forceps, through cutting, for endoscopes 0° / 12°



**JD-512-06**  
 Schere, doppelbeweglich, für Endoskope 0° / 12°  
 Scissors, double action, for endoscopes 0° / 12°



**JD-512-51**  
 Adapter für Optische Instrumente zur Verwendung mit Resektoskop-Schäften  
 (24-27 Charr.)  
 Adaptor for optical instruments for using with resectoscope sheaths (24-27  
 Charr.)

**Optische Steinzange für Cysto-Urethroskope**  
**Optical Stone Forceps for Cysto-Urethrosopes**



**JD-512-07**

Steinzange für Endoskope Ø 4,0 mm, 0°, 12°, 30° und Schaft 25 Charr.  
Stone crushing forceps for endoscopes Ø 4,0 mm, 0°, 12°, 30° and sheath 25 Charr.



**JD-512-50**

Adapter mit Hahn für den Einsatz mit Resektoskopschäften 26 - 28,5 Charr. ( nur verwendbar mit Außenschäft)  
Adaptor with stopcock for use with resectoscope sheath 26 - 28,5 Fr. ( to be used with outer sheath only)

**Flexible Zangen, Länge 400 mm**  
**Flexible forceps, length 400 mm**



*Schere, einfachbeweglich*  
*Scissors, single action*

JD-070-05	JD-070-07	JDE-070-09
5 Charr.	7 Charr.	9 Charr.
Ø 1,6 mm	Ø 2,3 mm	Ø 3,0 mm



*Probeexzisionszange, oval, doppelbeweglich*  
*Biopsy Forceps, oval, double action*

JD-070-15	JD-070-17	JD-070-19
5 Charr.	7 Charr.	9 Charr.
Ø 1,6 mm	Ø 2,3 mm	Ø 3,0 mm



*Probeexzisionszange, gezahnt, doppelbeweglich*  
*Biopsy Forceps, serrated, double action*

JD-070-25	JD-070-27	JD-070-29
5 Charr.	7 Charr.	9 Charr.
Ø 1,6 mm	Ø 2,3 mm	Ø 3,0 mm



*Faßzange, Alligatormaul, doppelbeweglich*  
*Grasping Forceps, alligator jaw, double action*

JD-070-35	JD-070-37	JD-070-39
5 Charr.	7 Charr.	9 Charr.
Ø 1,6 mm	Ø 2,3 mm	Ø 3,0 mm

**Halbstarre Zangen, Länge 400 mm**  
**Semi-rigid forceps, length 400 mm**



*Schere, einfachbeweglich*  
*Scissors, single action*

JD-071-05	JD-071-07	JDE-071-09
5 Charr.	7 Charr.	9 Charr.
Ø 1,6 mm	Ø 2,3 mm	Ø 3,0 mm



*Probeexzisionszange, oval, doppelbeweglich*  
*Biopsy Forceps, oval, double action*

JD-071-15	JD-071-17	JD-071-19
5 Charr.	7 Charr.	9 Charr.
Ø 1,6 mm	Ø 2,3 mm	Ø 3,0 mm



*Probeexzisionszange, gezahnt, doppelbeweglich*  
*Biopsy Forceps, serrated, double action*

JD-071-25	JD-071-27	JD-071-29
5 Charr.	7 Charr.	9 Charr.
Ø 1,6 mm	Ø 2,3 mm	Ø 3,0 mm



*Faßzange, Alligatormaul, doppelbeweglich*  
*Grasping Forceps, alligator jaw, double action*

JD-071-35	JD-071-37	JD-071-39
5 Charr.	7 Charr.	9 Charr.
Ø 1,6 mm	Ø 2,3 mm	Ø 3,0 mm

**Flexible isolierte Zangen, Länge 400 mm**  
**Flexible insulated forceps, length 400 mm**



*Schere, einfachbeweglich*  
*Scissors, single action*

JD-072-05	JD-072-07	JD-072-09
5 Charr.	7 Charr.	9 Charr.
Ø 1,6 mm	Ø 2,3 mm	Ø 3,0 mm



*Probeexzisionszange, oval, doppelbeweglich*  
*Biopsy Forceps, oval, double action*

JD-072-15	JD-072-17	JD-072-19
5 Charr.	7 Charr.	9 Charr.
Ø 1,6 mm	Ø 2,3 mm	Ø 3,0 mm



*Probeexzisionszange, gezahnt, doppelbeweglich*  
*Biopsy Forceps, serrated, double action*

JD-072-25	JD-072-27	JD-072-29
5 Charr.	7 Charr.	9 Charr.
Ø 1,6 mm	Ø 2,3 mm	Ø 3,0 mm



*Faßzange, Alligatormaul, doppelbeweglich*  
*Grasping Forceps, alligator jaw, double action*

JD-072-35	JD-072-37	JD-072-39
5 Charr.	7 Charr.	9 Charr.
Ø 1,6 mm	Ø 2,3 mm	Ø 3,0 mm

**Flexible Steinfänger und Schlingen**  
**Flexible stone extractors and loops**

**DORMIA Steinfänger, Länge 600 mm**  
**DORMIA Stone Extractor, length 600 mm**



<b>JD-040-03</b>
5 Charr.
Ø 1,6 mm



<b>JD-040-01</b>
Griff allein
Handle only

**HF Diathermieschlingen, Länge 500 mm**  
**HF Diathermy Loops, length 500 mm**



<b>JD-041-02</b>	<b>JD-041-03</b>
5 Charr.	7 Charr.
Ø 1,6 mm	Ø 2,3 mm



<b>JD-041-01</b>
Griff allein
Handle only

**Flexible Elektroden, Länge 530 mm  
Flexible Electrodes, length 530 mm**



**Nadelelektrode  
Needle Electrode**



JD-513-03	JD-513-04	JD-513-05	JD-513-07
3 Charr.	4 Charr.	5 Charr.	7 Charr.

**Knopfelektrode  
Button Electrode**



JD-513-13	JD-513-14	JD-513-15	JD-513-16	JD-513-17	JD-513-18	JD-513-19	JD-513-10
3 Charr.	4 Charr.	5 Charr.	6 Charr.	7 Charr.	8 Charr.	9 Charr.	10 Charr.

**Schlingenelektrode  
Loop Electrode**



JD-513-25	JD-513-27	JD-513-29	JD-513-20
5 Charr.	7 Charr.	9 Charr.	10 Charr.

**HF-Monopolar Anschlusskabel, 4,5 m**  
**HF-Monopolar Connecting Cables, 4,5 m**



**JD-550-01**

Für Instrumente an Berchtold / Martin / Aesculap GN Geräte  
For Instruments to Berchtold / Martin / Aesculap GN equipment



**JD-550-02**

Für Instrumente an Berchtold / Martin / Aesculap GN Geräte  
For Instruments to Berchtold / Martin / Aesculap GN equipment



**JD-550-03**

Für Instrumente an Erbe / ACC / ICC / Storz Geräte  
For Instruments to Erbe / ACC / ICC / Storz equipment



**JD-550-05**

Für Instrumente an Geräte mit 4 mm Bananenstecker  
For Instruments suitable to equipment with 4 mm banana plug

**Resektoskope für Endoskop 4,0 mm mit intermittierender Spülung  
Resectoscope for Endoscope 4,0 mm with intermittent irrigation**

**Endoskope Ø 4,0 mm  
Endoscopes Ø 4,0 mm**



<b>JB-430-30</b>	
30°	Blickrichtung / Direction of view
301 mm	Arbeitslänge / Working length

**Resektoskopschaft mit starrem Hahn  
Resectoscope sheath with fixed stopcock**



<b>JD-204-01</b>	<b>JD-207-01</b>
24 Charr.	27 Charr.

**Resektoskopschaft mit Zentralhahn  
Resectoscope sheath with central valve**



<b>JD-204-31</b>	<b>JD-207-05</b>
24 Charr.	27 Charr.

**Obturator  
Obturator**



<b>JD-207-50</b>	<b>JD-208-50</b>
24 Charr.	27 Charr.

# Resektoskopie Resectoscopy

## Resektoskope für Endoskop 4,0 mm mit Dauerspül-Doppelschaft-System, feststehend Resectoscope for Endoscope 4,0 mm with continuous flow double-sheath system, fixed

**Außenschaft  
Outer sheath**



JD-207-03	JD-208-13	JD-207-23	JD-207-43	JD-207-44
26 Charr.	28 Charr.	26 Charr.	26 Charr.	26 Charr.
Perforation rundum perforation surrounding	Perforation rundum perforation surrounding	Perforation oben / unten perforation upper / lower	Perforation rundum gefenstert perforation surrounding slits	Perforation oben gefenstert perforation upper slits

**Innenschaft  
Inner sheath**



JD-207-12	JD-208-12
26 Charr.	28 Charr.

**Obturator  
Obturator**



JD-207-50	JD-208-50
24 Charr.	27 Charr.

**Resektoskope für Endoskope 4,0 mm  
mit Dauerspül-Doppelschaft-System, drehbar  
Resectoscope for Endoscope 4,0 mm  
with continuous flow double-sheath system, rotatable**

**Außenschaft  
Outer sheath**



JD-207-14	JD-208-23	JD-207-13	JD-207-32	JD-207-33
26 Charr.	28 Charr.	26 Charr.	26 Charr.	26 Charr.
Perforation rundum perforation surrounding	Perforation rundum perforation surrounding	Perforation oben / unten perforation upper / lower	Perforation rundum gefenstert perforation surrounding slits	Perforation oben gefenstert perforation upper slits

**Innenschaft  
Inner sheath**



JD-207-22	JD-208-22
26 Charr.	28 Charr.

**Obturator  
Obturator**



JD-207-50	JD-208-50
24 Charr.	27 Charr.

**Obturatoren für Resektoskopschäfte Charr. 24 / 26 / 27 / 28,5**  
**Obturator for Resectoscope Sheath Fr. 24 / 26 / 27 / 28,5**

**Standardobturator**  
**Standard Obturator**

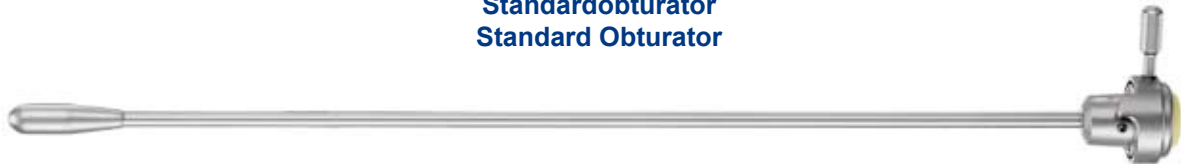

<b>JD-207-50</b>	<b>JD-208-50</b>
24 Charr.	27 Charr.

**Beweglicher Obturator**  
**Deflecting Obturator**



<b>JD-204-51</b>	<b>JD-207-51</b>
24 Charr.	27 Charr.

**Sichtobturator**  
**Viewing Obturator**



<b>JD-204-52</b>	<b>JD-207-52</b>
24 Charr.	27 Charr.

**Sichtobturator mit 5 Charr. Instrumentenkanal**  
**Viewing Obturator with 5 Fr. instrument channel**



<b>JD-204-53</b>	<b>JD-207-53</b>
24 Charr.	27 Charr.

---

**Arbeitselemente für Resektoskope und Endoskope 4,0 mm**  
**Working Elements for Resectoscopes and Endoscopes 4,0 mm**

**Arbeitselemente passiv**  
**Working Elements passive**



**JD-000-01**

passiv schneidend, Schnitt erfolgt durch Federdruck, geschlossener Griff  
passive cutting action, Spring-assistend cutting action, closed handle



**JD-000-02**

passiv schneidend, Schnitt erfolgt durch Federdruck, offener Griff  
passive cutting action, Spring-assistend cutting action, open handle

**Arbeitselemente für Resektoskope und Endoskope 4,0 mm**  
**Working Elements for Resectoscopes and Endoscopes 4,0 mm**

**Arbeitselemente aktiv**  
**Working Elements active**



**JD-000-11**

aktiv schneidend, Schnitt erfolgt gegen Federdruck, geschlossener Griff  
active cutting action, Manual cutting action, closed handle



**JD-000-12**

aktiv schneidend, Schnitt erfolgt gegen Federdruck, offener Griff  
active cutting action, Manual cutting action, open handle

**Elektroden für Resektoskope.  
Für Schäfte mit Intermittierender Spülung Charr. 24 und Charr. 27,  
sowie für Schäfte mit Dauerspülsystem Charr. 26 und Charr. 28,5.**

**Electrodes for Resectoscopes.  
For sheaths with intermittent irrigation Fr. 24 und Charr. 27,  
also for sheaths with continuous flow system Fr. 26 and Fr. 28,5.**



Schlingenelektroden, abgewinkelt 30°  
Loop electrodes, angled 30°

Kugelelektrode, 5 mm  
Ball electrode, 5 mm



<b>JD-050-01</b>	<b>JD-050-02</b>
24 Charr.	27 Charr.

<b>JD-050-09</b>	
24 Charr.	

Schlingenelektroden, abgewinkelt 90°  
Loop electrodes, angled 90°

Rollenelektrode, glatt, 3 mm  
Roller electrode, smooth, 3 mm



<b>JD-050-03</b>	<b>JD-050-04</b>
24 Charr.	27 Charr.

<b>JD-050-10</b>	
24 Charr.	

Schlingenelektroden, gerade  
Loop electrodes, straight

Rollenelektrode, glatt, 5 mm  
Roller electrode, smooth, 5 mm



<b>JD-050-05</b>	<b>JD-050-06</b>
24 Charr.	27 Charr.

<b>JD-050-11</b>	
24 Charr.	

Messerelektrode, abgewinkelt  
Knife electrodes, angled

Kegelelektrode  
Conical electrode



<b>JD-050-07</b>	
24 Charr.	

<b>JD-050-12</b>	
24 Charr.	

Kugelelektrode, 3 mm  
Ball electrode, 3 mm

Vaporisationselektroden, glatt, 3 mm  
Vaporization electrodes, smooth, 3 mm



<b>JD-050-08</b>	
24 Charr.	

<b>JD-050-15</b>	
24 Charr.	

**Elektroden für Resektoskope.**  
**Für Schäfte mit Intermittierender Spülung Charr. 24 und Charr. 27,**  
**sowie für Schäfte mit Dauerspülsystem Charr. 26 und Charr. 28,5.**

**Electrodes for Resectoscopes.**  
**For sheaths with intermittent irrigation Fr. 24 und Charr. 27,**  
**also for sheaths with continous flow system Fr. 26 and Fr. 28,5.**



Vaporisationselektroden, glatt, 5 mm  
Vaporization electrodes, smooth, 5 mm

Bandelektroden, abgewinkelt, 90°  
Band electrodes, angled, 90°



<b>JD-050-16</b>	
24 Charr.	

<b>JD-050-20</b>	<b>JD-050-21</b>
24 Charr.	27 Charr.

Kürette, scharf (nicht für HF!)  
Curette, sharp (not for use with HF)

Bandelektroden, abgewinkelt, 30°  
Band electrodes, angled, 30°



<b>JD-050-17</b>	<b>JD-050-18</b>
24 Charr.	27 Charr.

<b>JD-050-22</b>	<b>JD-050-23</b>
24 Charr.	27 Charr.

27 Charr.  
braun / brown



24 Charr.  
gelb / yellow



**Dünnes Resektoskop für Endoskope 2,7 / 2,9 mm mit intermittierender Spülung  
Thin Resectoscope for Endoscopes 2,7 / 2,9 mm with intermittent irrigation**

**Edoskope  
Endoscopes**



<b>JB-237-30</b>	<b>JB-239-30</b>	
30°	30°	Blickrichtung / Direction of view
301 mm	301 mm	Arbeitslänge / Working length
Ø 2,7 mm	Ø 2,9 mm	Durchmesser / Diameter

**Resektoskopschaft mit starrem Hahn  
Resectoscope sheath with fixed stopcock**



<b>JD-109-10</b>
22 Charr.

**Obturator  
Obturator**



<b>JD-109-50</b>
19 Charr.

**Dünnes Resektoskop für Endoskope 2.7 / 2.9 mm  
mit Dauerspül-Doppelschaft-System, drehbar**  
**Thin Resectoscope for Endoscopes 2.7 / 2.9 mm  
with continuous flow double-sheath system, rotatable**

**Außenschaft**  
**Outer sheath**

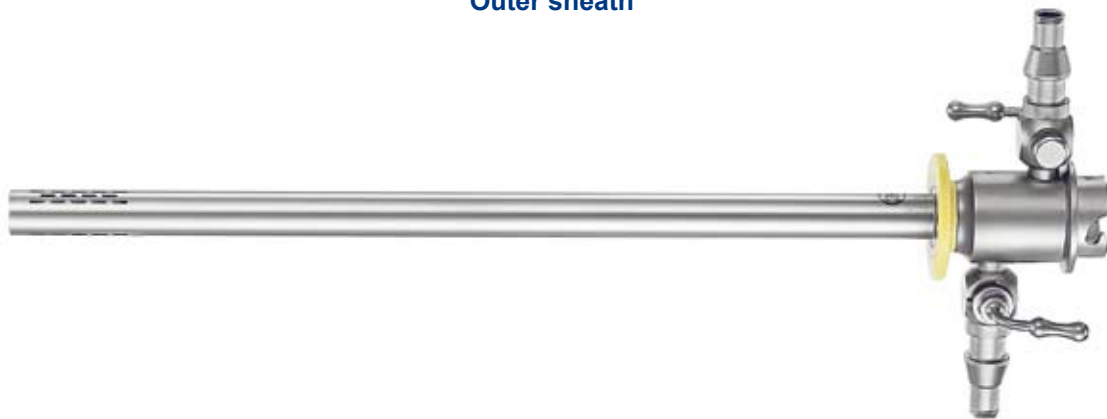

<b>JD-109-22</b>
22 Charr.

**Innenschaft**  
**Inner sheath**



<b>JD-109-12</b>
22 Charr.

**Obturator**  
**Obturator**



<b>JD-109-50</b>
19 Charr.

**Arbeitselemente für dünne Resektoskope**  
**Working Elements for thin Resectoscopes**

**Arbeitselemente passiv schneidend, Schnitt erfolgt durch Federdruck**  
**Working Elements passive cutting action, Spring-assisted cutting action**



<b>JD-109-01</b>
geschlossener Griff closed handle



<b>JD-109-03</b>
offener Griff open handle

**Arbeitselemente aktiv schneidend, Schnitt erfolgt gegen Federdruck**  
**Working Elements active cutting action, Manual cutting action**



<b>JD-109-02</b>
geschlossener Griff closed handle



<b>JD-109-04</b>
offener Griff open handle

# Resektoskopie Resectoscopy

---

**Elektroden für dünne Resektoskope.  
Für Schäfte mit Intermittierender Spülung Charr. 19,  
sowie für Schäfte mit Dauerspülsystem Charr. 22.**

**Electrodes for thin Resectoscopes.  
For sheath with intermittent irrigation Fr. 19,  
also for sheaths with continuous flow system Fr. 22.**



Schlingenelektroden, abgewinkelt 30°  
Loop electrodes, angled 30°



**JD-103-61**

19 Charr.

Kugelelektrode, 3 mm  
Ball electrode, 3 mm



**JD-103-64**

19 Charr.

Schlingenelektroden, gerade  
Loop electrodes, straight



**JD-103-62**

19 Charr.

Rollenelektrode, glatt, 3 mm  
Roller electrode, smooth, 3 mm



**JD-103-66**

19 Charr.

Messerelektrode, abgewinkelt  
Knife electrodes, angled



**JD-103-63**

19 Charr.

**HF-Monopolar Anschlusskabel, 4,5 m**  
**HF-Monopolar Connecting Cables, 4,5 m**



**JD-550-01**

Für Instrumente an Berchtold / Martin / Aesculap GN Geräte  
For Instruments to Berchtold / Martin / Aesculap GN equipment



**JD-550-02**

Für Instrumente an Berchtold / Martin / Aesculap GN Geräte  
For Instruments to Berchtold / Martin / Aesculap GN equipment



**JD-550-03**

Für Instrumente an Erbe / ACC / ICC / Storz Geräte  
For Instruments to Erbe / ACC / ICC / Storz equipment



**JD-550-05**

Für Instrumente an Geräte mit 4 mm Bananenstecker  
For Instruments suitable to equipment with 4 mm banana plug

**Evakulator**  
**Evakulator**

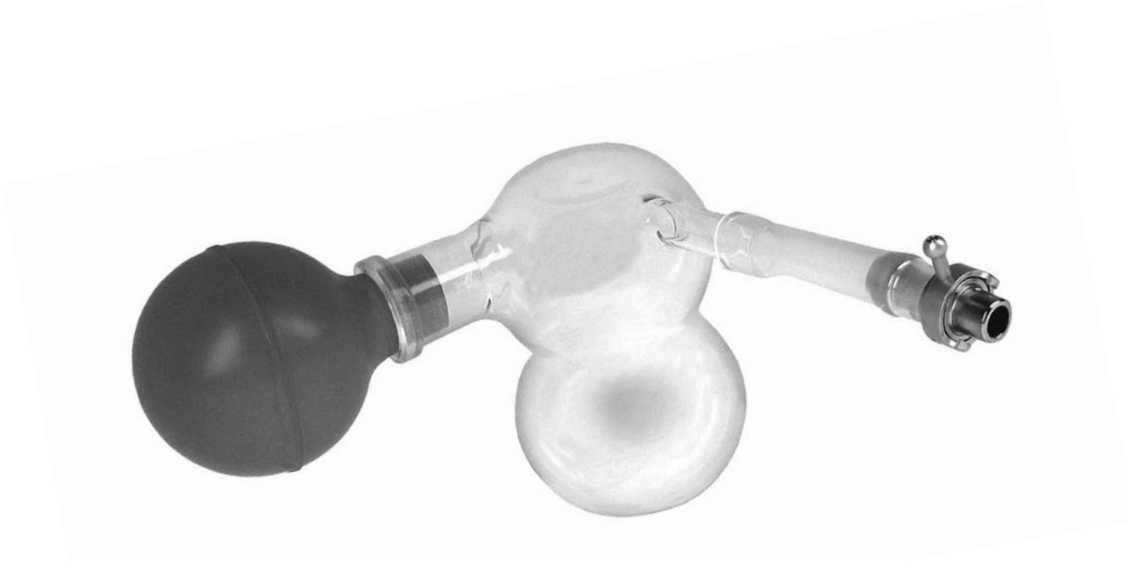

JD-030-01	JD-030-04	JD-030-05
Komplett mit Schaftanschluß und Verriegelung Complete with sheath connection	Glasbehälter für ELIK, allein Glass bulb for ELIK, only	Gummiball, allein Rubber bulb, only



JD-030-02
Schaftanschluß mit Verriegelung, allein Sheath connection with locking device, only



JD-030-03
Schaftanschluß mit Konus, allein Sheath connection with cone, only

Klassisches Urethrotom für Erwachsene  
Classical Urethrotome for Adults

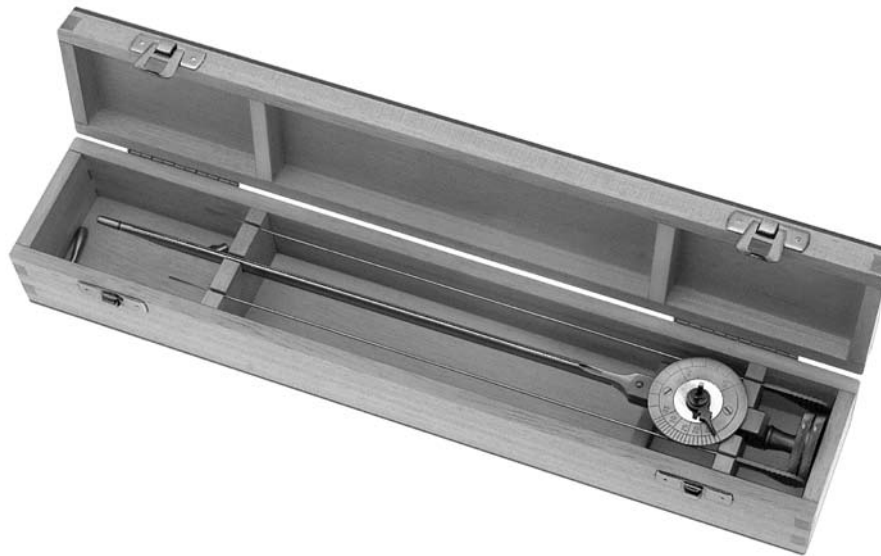

**GG-619-00**

bestehend aus: OTIS Dilatationsgerät, Kugelansatz, Ansatz flach, Ansatz konisch, 2 Messer  
consisting of: OTIS Dilation unit, ball tip, flat tip, conical tip, 2 knives



**GG-619-01**

OTIS Ersatzmesser  
OTIS Spare Blade

# Urethotomie Urethrotomy

## Optisches Urethrotom für Endoskop 4,0 mm Optical Urethrotome for Endoscope 4,0 mm

Endoscopes 4,0 mm  
Endoscopes 4,0 mm



<b>JB-430-30</b>	
30°	Blickrichtung / Direction of view
301 mm	Arbeitslänge / Working length

## Urethroskopschaft Urethroscope Sheath



<b>JD-221-01</b>	
21 Charr., mit 1x5 Charr. Instrumenenkanal 21 Fr., with 1x5 Fr. instrument channel	

## Endoskopbrücke Endoscope Bridges



<b>JD-221-02</b>	
mit 1x5 Charr. Instrumenenkanal with 1x5 Fr. instrument channel	

## Führungsrohr Guide Tube



<b>JD-221-03</b>	
seitlich offen, zum Einführen eines Ballonkatheters lateral open, to insert a ballon catheter	

Optisches Urethrotom für Endoskop 4,0 mm  
Optical Urethrotome for Endoscope 4,0 mm

Standardobturator  
Standard Obturator



**JD-221-50**

für Urethrotomschaft für JD-221-01  
for Urethrotome sheath JD-221-01

Zubehör optional  
Optional Accessories



**JD-221-04**

Zusatzschaft für Dauerspülung, 25 Charr.  
Supplementary sheath for continuous irrigation 25 Fr.



**JD-221-51**

Obturator mit 1 x 5 Charr. Instrumentenkanal  
Obturator with 1 x 5 Fr. instrument channel



**JD-221-06**

Sichtobturator  
Viewing obturator

**Arbeitselemente für Urethrotom**  
**Working Elements for Urethrotome**



**JD-000-01**

passiv schneidend, Schnitt erfolgt durch Federdruck, geschlossener Griff  
passive cutting action, Spring-assisted cutting action, closed handle



**JD-000-02**

passiv schneidend, Schnitt erfolgt durch Federdruck, offener Griff  
passive cutting action, Spring-assisted cutting action, open handle

Strikturmesser für Urethrotomie zum kalten Schneiden von Harnröhrenstrikturen  
Stricture blades for Urethrotomy for the cold cutting of urethral strictures



<b>JD-221-61</b>
gerade straight



<b>JD-221-64</b>
ringförmig ring sharpened



<b>JD-221-62</b>
rund round



<b>JD-221-65</b>
sichelförmig sickle sharpened



<b>JD-221-63</b>
gerade, Wellenschliff straight, wave sharpened

# Urethro-Renoskopie

## Urethro-Rensocopy

### Halbstarres Urethro-Renoskop, autoklavierbar

### Semi-rigid Urethro-Renoscope, autoclavable



**JB-730-12**

Schaft Ø 7,5 Charr., Arbeitskanal Ø 5 Charr.  
Shaft Ø 7,5 FR., Instrument channel Ø 5 FR.



**JB-730-01**

Adapter für EMS-Lithotriptor  
Adapter for EMS-Lithotriptor

### Flexible Zangen, Länge 600 mm, 5 Charr., Ø 1,6 mm

### Flexible forceps, length 600 mm, 5 FR., Ø 1,6 mm



**JD-076-05**

Schere, einfachbeweglich  
Scissors, single action



**JD-076-25**

Probeexzisionszange, gezahnt, doppelbeweglich  
Biopsy Forceps, serrated, double action



**JD-076-15**

Probeexzisionszange, oval, doppelbeweglich  
Biopsy Forceps, oval, double action



**JD-076-35**

Faßzange, Alligatormaul, doppelbeweglich  
Grasping Forceps, alligator jaw, double action

**Flexible Steinfänger und Schlingen  
Flexible stone extractors and loops**

**DORMIA Steinfänger, Länge 600 mm  
DORMIA Stone Extractor, length 600 mm**



<b>JD-040-03</b>
5 Charr.
Ø 1,6 mm

<b>JD-040-01</b>
Griff allein Handle only

**HF Diathermieschlingen, Länge 500 mm  
HF Diathermy Loops, length 500 mm**



<b>JD-041-02</b>	<b>JD-041-03</b>
5 Charr.	7 Charr.
Ø 1,6 mm	Ø 2,3 mm

<b>JD-041-01</b>
Griff allein Handle only

**HF-Monopolar Anschlusskabel, 4,5 m - siehe Seite 12  
HF-Monopolar Connecting Cables, 4,5 m - see page 12**

**Kinder-Cysto Urethroskop für Endoskope 2,7 mm**  
**Pediatric Cysto-Urethroscope for Endoscopes 2,7 mm**

**Kinder Endoskope, Ø 2,7 mm**  
**Pediatric Endoscopes, Ø 2,7 mm**



JB-257-00	JB-257-30	JB-257-70	
0°	30°	70°	Blickrichtung / Direction of view
187,5 mm	187,5 mm	187,5 mm	Arbeitslänge / Working length

**Schäfte mit 2 starren Hähnen**  
**Sheaths with 2 fixed stopcocks**



JD-019-01	JD-111-01	JD-113-01	
9 Charr.	11 Charr.	13 Charr.	Durchmesser / Diameter
1 x 3 Charr.	1 x 3 Charr.	1 x 3 Charr.	Durchlass / Capacity
rot / red	rot / red	rot / red	Kennfarbe / Colour code

**Standardobturator**  
**Standard Obturator**



JD-019-05	JD-111-05	JD-113-05	
9 Charr.	11 Charr.	13 Charr.	

**Endoskopbrücke zur Verwendung mit Schaft JD-113-01**  
**Endoscope bridge to be used with sheath JD-113-01**



<b>JD-113-50</b>
13 Charr.

**ALBARRAN Arbeitseinsatz zur Verwendung mit Schaft JD-113-01**  
**ALBARRAN working element to be used with sheath JD-113-01**



<b>JD-113-51</b>
13 Charr.

**Flexible Steinfänger und Schlingen  
Flexible stone extractors and loops**

**DORMIA Steinfänger, Länge 600 mm  
DORMIA Stone Extractor, length 600 mm**



<b>JD-070-23</b>
Probeexzisionszange, oval, doppelbeweglich Biopsy Forceps, oval, double action



<b>JD-070-33</b>
Faßzange, Alligatormaul, doppelbeweglich Grasping Forceps, alligator jaw, double ac

**Flexible Elektroden, Länge 530 mm  
Flexible Electrodes, length 530 mm**



**Nadelektrode  
Needle Electrode**



<b>JD-513-03</b>
3 Charr.

**Knopfelektrode  
Button Electrode**



<b>JD-513-13</b>
3 Charr.

**Kinder-Resektoskop für Endoskope 2,7 mm**  
**Pediatric Resectoscope for Endoscopes 2,7 mm**

**Kinder Endoskope, Ø 2,7 mm**  
**Pediatric Endoscopes, Ø 2,7 mm**



<b>JB-257-00</b>	
0°	Blickrichtung / Direction of view
187,5 mm	Arbeitslänge / Working length

**Schäfte mit 1 starren Hahn**  
**Sheaths with 1 fixed stopcock**



<b>JD-101-10</b>	<b>JD-103-10</b>	
11 Charr.	13 Charr.	Durchmesser / Diameter
rot / red	rot / red	Kennfarbe / Colour code

**Standardobturator**  
**Standard Obturator**



<b>JD-101-50</b>	<b>JD-103-50</b>	
11 Charr.	13 Charr.	

**Endoskopbrücke mit 3 Charr. Instrumentenkanal**  
**zur Verwendung mit Schaft JD-103-10**  
**Edoscope bridge with 3 Fr. instrument channel**  
**to used with sheath JD-103-10**



<b>JD-123-02</b>
13 Charr.

**Arbeitselement passiv für JD-103-10**  
**Working Element passive for JD-103-10**



<b>JD-103-01</b>
13 Charr.

**Kinder-Urethrotome für Endoskope 2,7 mm  
Pediatric Urethrotome for Endoscopes 2,7 mm**

**Kinder Endoskope, Ø 2,7 mm  
Pediatric Endoscopes, Ø 2,7 mm**



<b>JB-257-00</b>	
0°	Blickrichtung / Direction of view
187,5 mm	Arbeitslänge / Working length

**Schäfte mit 1 starren Hahn  
Sheaths with 1 fixed stopcock**

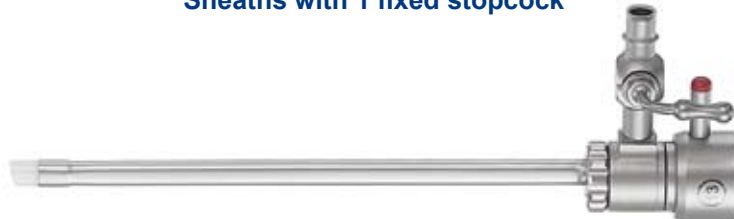

<b>JD-121-01</b>	<b>JD-123-01</b>	
11 Charr.	13 Charr.	Durchmesser / Diameter
rot / red	rot / red	Kennfarbe / Colour code

**Standardobturator für Urethrotom  
Standard Obturator for Urethrotome**



<b>JD-121-03</b>	<b>JD-123-03</b>	
11 Charr.	13 Charr.	

**Endoskopbrücke mit 3 Charr. Instrumentenkanal  
zur Verwendung mit Schaft JD-103-01  
Edoscope bridge with 3 Fr. instrument channel  
to used with sheath JD-103-01**



<b>JD-123-02</b>
13 Charr.

**Arbeitselement passiv für JD-103-01  
Working Element passive for JD-103-01**



<b>JD-103-01</b>
13 Charr.

**Strikturskalpelle zum kalten Schneiden von Harnröhrenstrikturen,  
für Kinder-Urethrotom mit Endoskop 2,7 mm**



*gerade  
straight*



<b>JD-121-61</b>	<b>JD-123-61</b>
11 Charr.	13 Charr.

*sichelförmig  
sickle sharpened*



<b>JD-121-64</b>	<b>JD-123-64</b>
11 Charr.	13 Charr.

*rund  
round*



<b>JD-121-62</b>	<b>JD-123-62</b>
11 Charr.	13 Charr.

*hakenförmig  
hook sharpened*



<b>JD-121-65</b>	<b>JD-123-65</b>
11 Charr.	13 Charr.



Kugelelektrode, abgewinkelt 30°  
Ball electrodes, angled 30°



<b>JD-121-55</b>

Schlingenelektrode, groß  
Loop electrodes, large



<b>JD-121-50</b>

Schlingenelektroden, klein  
Loop electrodes, small



<b>JD-121-51</b>

## Metallkatheter für Männer Metal Catheters for men



<b>GG-121-08</b>	<b>GG-121-10</b>	<b>GG-121-12</b>	<b>GG-121-14</b>	<b>GG-121-16</b>	<b>GG-121-18</b>
8 Charr.	10 Charr.	125 Charr.	14 Charr.	16 Charr.	18 Charr.

<b>GG-121-20</b>	<b>GG-121-22</b>	<b>GG-121-24</b>
20 Charr.	22 Charr.	24 Charr.

## Metallkatheter für Frauen Metal Catheters for women



<b>GG-123-08</b>	<b>GG-123-10</b>	<b>GG-123-12</b>	<b>GG-123-14</b>	<b>GG-123-16</b>	<b>GG-123-18</b>
8 Charr.	10 Charr.	125 Charr.	14 Charr.	16 Charr.	18 Charr.

<b>GG-123-20</b>	<b>GG-123-22</b>	<b>GG-123-24</b>
20 Charr.	22 Charr.	24 Charr.

## GUYON Katheter-Einführungsinstrumente GUYON Catheter Introducing Instruments



<b>GG-814-39</b>
39 cm



<b>GG-815-35</b>
35 cm

# Penisklemmen Penis Clamps

---

## STOCKMANN

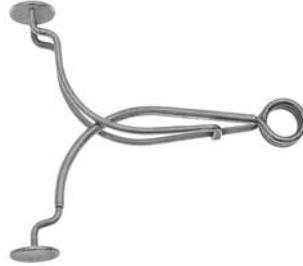

<b>GG-715-08</b>
------------------

8 cm
------

## STRAUSS



<b>GG-717-11</b>
------------------

11 cm
-------

## DITTEL Dilatationsbougies, gerade, 220 mm DITTEL Dilating bougies, straight, 220 mm



<b>GG-225-08</b>	<b>GG-225-09</b>	<b>GG-225-10</b>	<b>GG-225-11</b>	<b>GG-225-12</b>	<b>GG-225-13</b>
8 Charr.	9 Charr.	10 Charr.	11 Charr.	12 Charr.	13 Charr.

<b>GG-225-14</b>	<b>GG-225-15</b>	<b>GG-225-16</b>	<b>GG-225-17</b>	<b>GG-225-18</b>	<b>GG-225-19</b>
14 Charr.	15 Charr.	16 Charr.	17 Charr.	18 Charr.	19 Charr.

<b>GG-225-20</b>	<b>GG-225-21</b>	<b>GG-225-22</b>	<b>GG-225-23</b>	<b>GG-225-24</b>	<b>GG-225-25</b>
20 Charr.	21 Charr.	22 Charr.	23 Charr.	24 Charr.	25 Charr.

<b>GG-225-26</b>	<b>GG-225-27</b>	<b>GG-225-28</b>	<b>GG-225-29</b>	<b>GG-225-30</b>
26 Charr.	27 Charr.	28 Charr.	29 Charr.	30 Charr.

## DITTEL Dilatationsbougies, gebogen, 350 mm DITTEL Dilating bougies, curved, 350 mm



<b>GG-227-08</b>	<b>GG-227-09</b>	<b>GG-227-10</b>	<b>GG-227-11</b>	<b>GG-227-12</b>	<b>GG-227-13</b>
8 Charr.	9 Charr.	10 Charr.	11 Charr.	12 Charr.	13 Charr.

<b>GG-227-14</b>	<b>GG-227-15</b>	<b>GG-227-16</b>	<b>GG-227-17</b>	<b>GG-227-18</b>	<b>GG-227-19</b>
14 Charr.	15 Charr.	16 Charr.	17 Charr.	18 Charr.	19 Charr.

<b>GG-227-20</b>	<b>GG-227-21</b>	<b>GG-227-22</b>	<b>GG-227-23</b>	<b>GG-227-24</b>	<b>GG-227-25</b>
20 Charr.	21 Charr.	22 Charr.	23 Charr.	24 Charr.	25 Charr.

<b>GG-227-26</b>	<b>GG-227-27</b>	<b>GG-227-28</b>	<b>GG-227-29</b>	<b>GG-227-30</b>
26 Charr.	27 Charr.	28 Charr.	29 Charr.	30 Charr.

# Dilatationsbougies Dilating Bougies

---

**VAN BUREN Dilatationsbougies, 275 mm**  
**VAN BUREN Dilating bougies, 275 mm**



<b>GG-021-08</b>	<b>GG-021-10</b>	<b>GG-021-12</b>	<b>GG-021-14</b>	<b>GG-021-16</b>	<b>GG-021-18</b>
8 Charr.	10 Charr.	12 Charr.	14 Charr.	16 Charr.	18 Charr.

<b>GG-021-20</b>	<b>GG-021-22</b>	<b>GG-021-24</b>	<b>GG-021-26</b>	<b>GG-021-28</b>	<b>GG-021-30</b>
20 Charr.	22 Charr.	24 Charr.	26 Charr.	28 Charr.	30 Charr.

<b>GG-021-32</b>	<b>GG-021-34</b>	<b>GG-021-36</b>
32 Charr.	34 Charr.	36 Charr.







Rev.: 12.11.2008



CM Instrumente GmbH  
Gänsäcker 56  
78532 Tuttlingen  
Germany

Tel. +49 7462 20420-70  
Fax +49 7462 20420-62  
info@cm-instrumente.de  
www.cm-instrumente.de